

Enabling Switches



Enabling Switches



Grip Switches



Teaching Pendants

Compare and select the right product for you.

[Selection Guide](#)

[D-063](#)

HE1B

3-position enabling switch to avoid hazards.

[D-065](#)

HE2B

Multi-contact 3-position enabling switches pendants.

[D-068](#)

HE3B

Rectangular operator with $\varnothing 16$ mm mounting for easy installation.

[D-072](#)

HE5B

Round-shaped operator for $\varnothing 16$ mm mounting hole.

[D-075](#)

HE6B

3-position enabling switch with monitoring contacts.

[D-079](#)

HE2G

Compact, light-weight grip style enabling switch.

[D-083](#)

HE1G-L

The distinctive tactile feedback makes it easy to know the current position of the switch.

[D-088](#)

Actuators

Actuator with Plastic Holder

[D-092](#)

HE1G

Ergonomically designed grip style enabling switch with two 3-position enabling switches.

[Contact us](#)

HG1H

A small and lightweight teaching pendant.

[Contact us](#)

HG1T

Operability combined with communication function.

[Contact us](#)

Leading the industry by providing human-robot collaborative safety

As we enter an era where humans and machines/robots work collaboratively, IDEC promotes the next generation of safety concepts, Safety2.0 (Collaborative Safety). The conventional way to raise the safety level is to implement safety measures to machines and to eliminate areas where humans and machines coexist. In Safety2.0, all these parties—humans, machines, and the environment—collaborate and maintain a high level of safety. Based on the concept, IDEC is developing new businesses, such as constructing flexible yet highly safe and productive production systems and providing safety consultation services for collaborative robot systems.

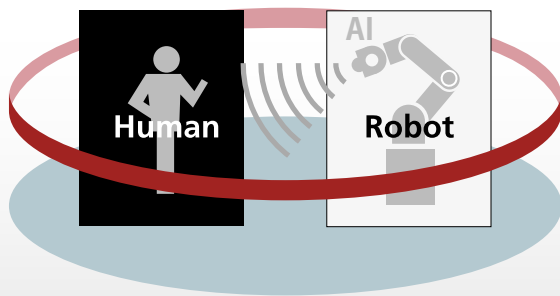

IDEC has gained knowledge and experience to achieve collaborative safety on-site. We support the safety of our customer as an experienced safety component supplier.

Safety Components



We provide various safety components and solutions as a leading company in safety products and technologies.

System Integration



We provide the most suitable system solution as a collaborative safety robot system integrator that achieves both productivity and safety.

Safety Evangelist



With extensive experience in manufacturing and vast knowledge of machine safety, we provide safety consultation service that helps you achieve both safety and productivity.



Collaborative Safety Robot Technical Center (Ichinomiya City, Aichi)

COLLABORATIVE SAFETY ROBOT TECHNICAL CENTER

We provide collaborative robot systems that match the needs of its customers, contributing to improvements in quality and productivity by reducing the effects of labor shortages.

For information on Collaborative Safety Robot Technical Center, contact:

IDEC FACTORY SOLUTIONS CORPORATION

TEL: +81-586-73-8300

Next generation safety

Compliant with international standards

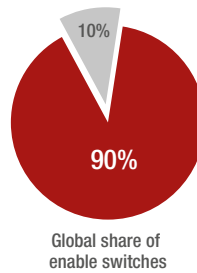
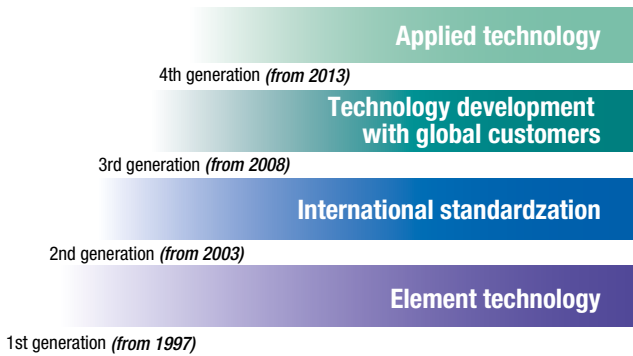

IDEC participated in the creation of international safety standards.

Grip switches widely used for machine tools and semiconductor manufacturing equipment.



IEC 60947-5-8(2008)

IEC 60947-5-8 (2006)
 Low-voltage switchgear and controlgear
 – Part 5-8: Control circuit devices and switching elements –
 Three-position enabling switches

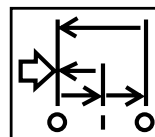

3-position Enabling Switch Symbol (IEC 60947-5-8)

3-position enabling switches

Ergonomically-designed OFF-ON-OFF 3-position operation

By holding an enabling switch, an operator can avert danger when a machine operates unexpectedly. When the panicked operator either releases or grasps tightly the enabling switch, the switch disables the machine operation in either situations.

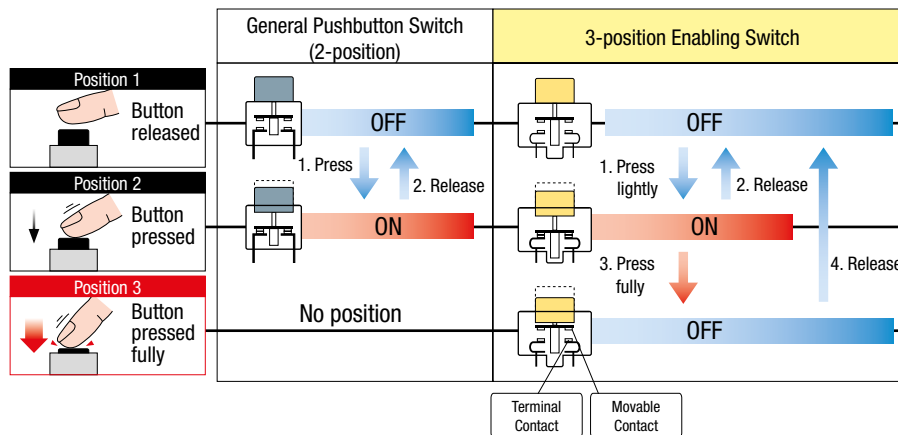







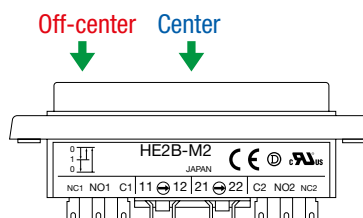
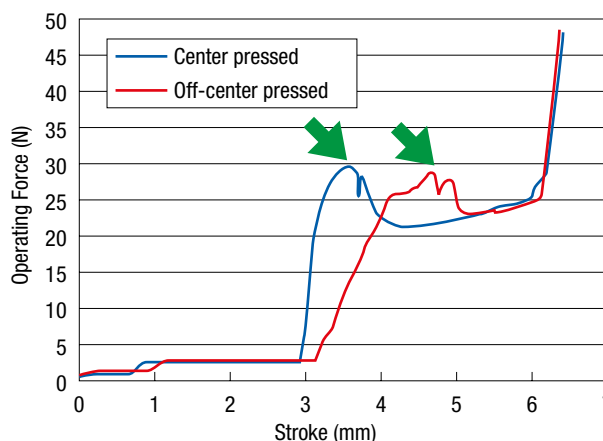
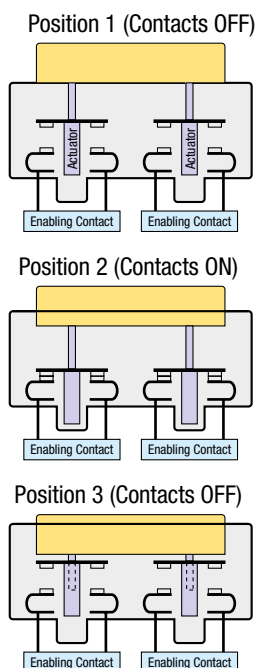





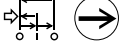

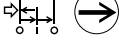

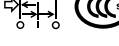

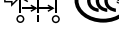

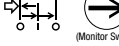

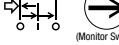

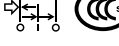





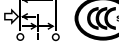





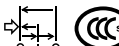



























Duplicated actuators and contacts

In IDEC's enabling switches, both actuators and contacts are duplicated. When a hazard must be stopped at high safety level, disparity of two contacts must be detected using safety relay module so that failures such as damage or welding of contacts and actuators can be detected.

























































As for usability, the operating force required to shift the switch from position 2 to 3 is the same when the button is pressed on the center or off-center. Operating force does not increase even when pressed off-center by one finger. High durability is also provided; operating force hardly changes after 10000 operations.



Enabling Switch Selection Chart

		Model	Marks	Page		
For Installation in Equipment	3-position Switch with 1 Contact (2 switches are used for duplication)	Panel Top Installation	IP40	HE1B-M1N  C     	D-065	
		Panel Side Installation	IP40	HE1B-M1  C     		
For Direct Operation with Hand	3-position Switch with 2 Contacts	Installed in Rectangular Panel Cut-out (4-finger operation)	w/o Monitor Switch for Position Detection	IP40	HE2B-M200  C     	D-068
				IP65	HE2B-M200P*  C       <small>(some models only)</small>	
				IP40	HE2B-M211 HE2B-M222  C       <small>(Monitor Switch)</small>	
				IP65	HE2B-M211P* HE2B-M222P*  C        <small>(Monitor Switch) (some models only)</small>	
				IP65	HE6B-M200  C     	
	Installed in Rectangular Panel Cut-out (1- or 2-finger operation)	w/o Monitor Switch for Position Detection	IP65	HE6B-M211  C       <small>(Monitor Switch)</small>	D-072	
		w/ Monitor Switch for Position Detection	IP65	HE3B-M2  C     		
			IP40	HE3B-M2P*  C     		
	Installed in ø16mm Round Hole (thumb or 3-finger operation)		IP40	HE5B-M2P*  C     	D-075	
			IP65			

Enabling Switch Selection Chart

				Model	Marks	Page		
For Thumb Operation			Without	HE9Z-GSH51 +HE5B-2P*	 c   	D-077		
	Grip Style Operation	Small	Light	With	HE2G-21S*	 c         (some models only)	(Note 1)	D-084
(Note 2)								
Standard		Light	Without	Emergency Stop Switch	HE2G-21S*E	 c         (some models only)		
				Momentary Pushbutton	HE1G-L20ME	 c        (some models only)		
Standard		Light	Without	Momentary Pushbutton	HE1G-L20MB	 c        (some models only)		D-089
				With	HE1G-L21SM	 c         (some models only)		
			Momentary Pushbutton	HE1G-L21SMB	 c         (some models only)			

Note 1: With momentary pushbutton or key selector switch

Note 2: With emergency stop switch and momentary pushbutton or key selector switch

HE1B Basic Three-position Enabling Switches

3-position enabling switch to avoid hazards.

Ideal for installing in teach pendants and other enabling devices.



• See website for details on approvals and standards.

HE1B

Shape	Mounting Style	Contact Configuration	Part No.	Package Quantity
	Side Mounting	1 contact (3-position)	HE1B-M1	10
	Top Mounting		HE1B-M1N	

• Minimum applicable load (reference value): 3V AC/DC, 5 mA

Ratings

Contact Ratings

Rated Insulation Voltage (Ui)		250V			
Rated Thermal Current (Ith)		5A			
Rated Voltage (Ue)		30V	125V	250V	
Rated Current (Ie)	AC 50/60 Hz	Resistive Load (AC-12)	—	3A	1.5A
		Inductive Load (AC-15)	—	1.5A	0.75A
	DC	Resistive Load (DC-12)	2A	0.4A	0.2A
		Inductive Load (DC-13)	1A	0.22A	0.1A
Contact Configuration (3-position switch)		1 contact			

• Minimum applicable load (reference value): 3V AC/DC, 5 mA
(Applicable range is subject to the operating conditions and load.)

Specifications

Applicable Standards	UL508 (UL recognized), CSA C22.2, No. 14 (c-UL recognized), IEC/EN 60947-5-1, IEC/EN 60947-5-8 (TUV approval), IEC/EN60947-5-1, UL508 (UL recognized), CSA C22.2 No.14 (c-UL recognized)
HE1B Applicable Standards for Use	ISO 12100-1, -2/EN12100-1, -2, IEC 60204-1 / EN 60204-1 ISO 11161 / prEN 11161, ISO 10218 / EN 775, ANSI/RIA R15.06, ANSI B11.19
HE2B Operating Temperature	-25 to +60°C (no freezing)
HE3B Relative Humidity	45 to 85% (no condensation)
Storage Temperature	-40 to +80°C (no freezing)
HE5B Pollution Degree	2
HE6B Contact Resistance	50 mΩ maximum (initial value)
Insulation Resistance	100 MΩ minimum (500V DC megger)
HE2G Impulse Withstand Voltage	2.5 kV
HE1G-L Operating Frequency	1,200 operations per hour
Mechanical Durability	Position 1 → 2 → 1: 1,000,000 operations Position 1 → 2 → 3 → 1: 100,000 operations
Electrical Durability	100,000 operations minimum
Shock Resistance	Operating extremes: 150 m/s ² Damage limits: 1,000 m/s ²
Vibration Resistance	Operating extremes: 5 to 55 Hz, amplitude 0.5 mm Damage limits: 16.7 Hz, amplitude 1.5 mm
Terminal Style	Solder terminal
Applicable Wire	1 cable, 0.5 mm ² maximum
Terminal Soldering Heat Resistance	310 to 350°C, 3 seconds maximum
Terminal Tensile Strength	20N minimum
Mounting Screw Recommended Tightening Torque	HE1B-M1: M3 screw / 0.5 to 0.8 N-m HE1B-M1N: M2.6 screw / 0.4 to 0.6 N-m
Degree of Protection	IP40, except terminals (IEC 60529)
Conditional Short-circuit Current	50A (250V) (Use 250V/10A fast-blow fuse for short-circuit protection.)
Direct Opening Force	30N minimum (position 2 → 3)
Operator Strength	250N minimum
Weight (approx.)	6g

Operation Characteristics

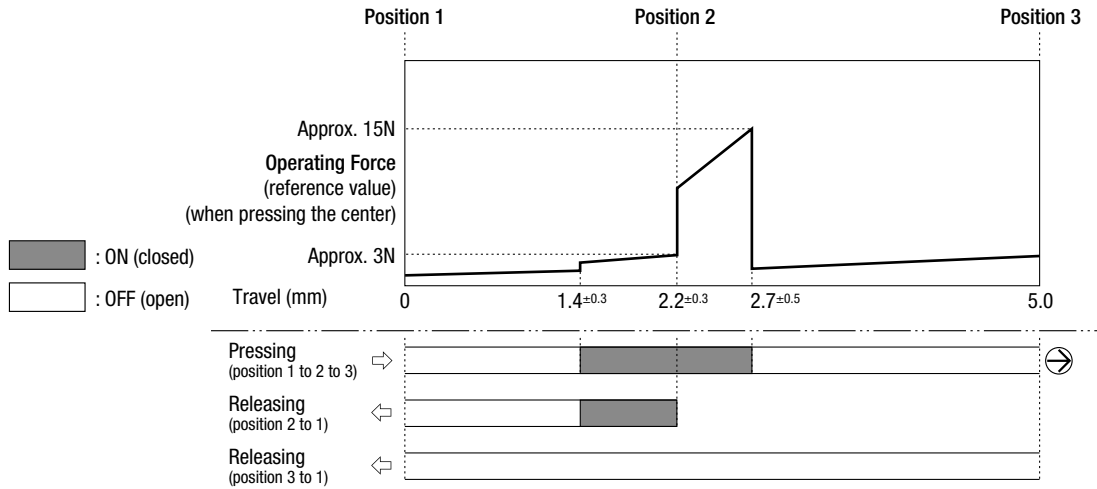

Dimensions

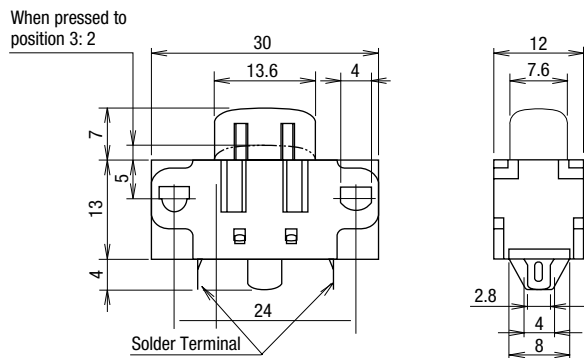

Mounting Hole Layout
HE1B-M1 (side mounting)

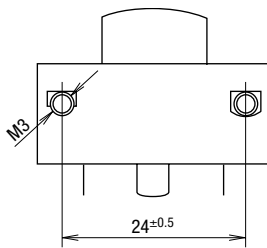

• M3 mounting screws must be supplied by the user.

HE1B-M1N (top mounting)

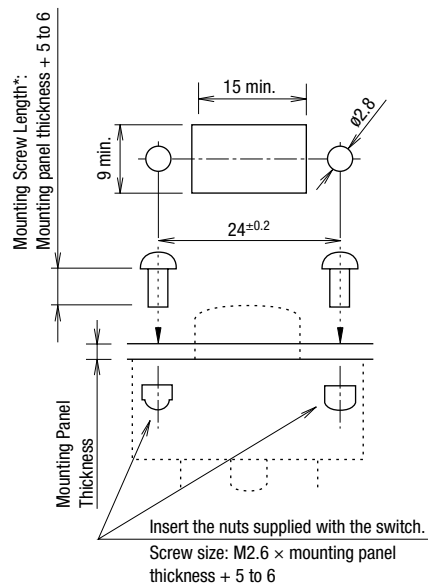

Note: When installed on a mounting panel thicker than 2 mm, the actuator surface is below the panel when the button is pressed to position 3.

* Two M2.6 nuts are supplied. Mounting screws (M2.6) must be supplied by the user.

All dimensions in mm.

- APEM
- Switches & Pilot Lights
- Control Boxes
- Emergency Stop Switches
- Enabling Switches
- Safety Products
- Explosion Proof
- Terminal Blocks
- Relays & Sockets
- Circuit Protectors
- Power Supplies
- LED Illumination
- Controllers
- Operator Interfaces
- Sensors
- AUTO-ID

- HE1B
- HE2B
- HE3B
- HE5B
- HE6B
- HE2G
- HE1G-L
- Actuator w/ Plastic Holder

HE1B Basic Three-position Enabling Switches

 Safety Precautions

- The enabling switches have been designed for industrial purposes. Use for residential, commercial, or lighting purposes may cause unwanted electromagnetic disturbances in which case the user may be required to take adequate mitigation measures. (IEC60947-1, Clause 5.3)
- In order to avoid electric shock or fire, turn the power off before installation, removal, wiring, maintenance, or inspection of the enabling switch.
- When using the enabling switch in a safety related part of a control system, use the enabling switch properly in accordance with the safety standards and regulations of the actual machine, system, and application, of the country or region where the enabling switch is used. Also, perform a risk assessment before using the enabling switch.
- Do not disable the safety function of the enabling switch by using tape, elastic band, or by disfiguring the rubber boot, otherwise the loss of enabling switch function may cause serious accidents.
- Perform a risk assessment in actual applications as strong force may be applied to the switch when depressed to position 3.
- Perform a risk assessment for the shape and structure of the part where the enabling switch is installed, to prevent unintended operation of the enabling switch. For example, an enabling switch protruding from the teach pendant may result in an unintended operation of the enabling switch.
- Strong force may be applied to a 3-position enabling switch when pressed to position 3. Provide sufficient strength to the part where 3-position enabling switches will be installed.
- Use wires of the proper size to meet voltage and current requirements, and solder the wires correctly according to the wiring instruction described below. If soldering is incomplete, the wire may heat during operation, causing a fire hazard.
- Do not apply excessive force to the enabling switch.
- Follow the wiring instructions mentioned in the instruction manual.

Instructions

Operating Instructions

- The enabling switch permits machine operation only while the enabling switch is manually operated for robot teaching or other purposes in hazardous areas. Make sure that the control system is designed to activate the machine only when the enabling switch is at position 2 (2.2mm) operating travel.
- To prevent malfunction of the button, provision for protection is required.

Installation Instructions

- Provide sufficient strength to the mounting panel. Insufficient strength of the mounting panel or excessive operating force may damage the enabling switch, resulting in electric shock or fire.

Wiring Instructions

- Applicable wire size: 0.5 mm² maximum × 1 pc.
- Solder the terminal at a temperature of 310 to 350°C within 3 seconds using a soldering iron. Sn-Ag-Cu type is recommended when using lead-free solder. Do not use flow or dip soldering.
- When soldering, take care not to touch the enabling switch with the soldering iron. Also ensure that no tensile force is applied to the terminal. Do not bend the terminal or apply excessive force to the terminal.
- Use non-corrosive liquid rosin as soldering flux.

APEM

Switches &
Pilot Lights

Control Boxes

Emergency
Stop SwitchesEnabling
Switches

Safety Products

Explosion Proof

Terminal Blocks

Relays & Sockets

Circuit
Protectors

Power Supplies

LED Illumination

Controllers

Operator
Interfaces

Sensors

AUTO-ID

HE1B

HE2B

HE3B

HE5B

HE6B

HE2G

HE1G-L

Actuator w/
Plastic Holder

HE2B Double Three-position Enabling Switches

Multi-contact 3-position enabling switches Ideal for installing in large teach pendants

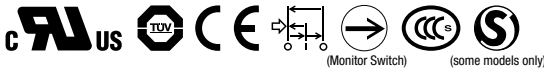

• See website for details on approvals and standards.

HE2B

Shape	Style	Contact Configuration			Part No.	Package Quantity
		3-position Switch	Return Monitor Switch	Depress Monitor Switch		
	Without Rubber Boot	2	0	0	HE2B-M200	10
		2	1	1	HE2B-M211	10
		2	2	2	HE2B-M222	10
	Rubber Boot Material: Silicon Rubber Color: B: black Y: yellow	2	0	0	HE2B-M200P*	10
		2	1	1	HE2B-M211P*	10
		2	2	2	HE2B-M222P*	10
	Rubber Boot Material: NBR/PVC Polyblend Color: gray	2	0	0	HE2B-M200PN1	10
		2	1	1	HE2B-M211PN1	10
		2	2	2	HE2B-M222PN1	10

Note: Specify a rubber boot color code in place of * in the Ordering No.

Part No. Development

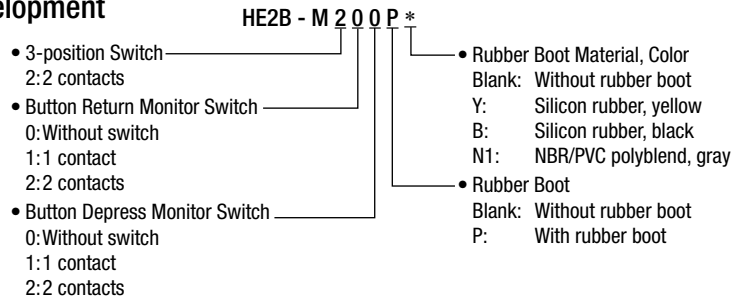

Ratings

Contact Ratings

Rated Insulation Voltage (Ui)		250V				
Rated Thermal Current (Ith)		3A				
Rated Voltage (Ue)		30V	125V	250V		
Rated Current (Ie)	3-position Switch	AC	Resistive Load (AC-12)	—	1A	0.5A
			Inductive Load (AC-15)	—	0.7A	0.5A
		DC	Resistive Load (DC-12)	1A	0.2A	—
			Inductive Load (DC-13)	0.7A	0.1A	—
	Button Return Monitor Switch Button Depress Monitor Switch	AC	Resistive Load (AC-12)	—	2.5A	1.5A
			Inductive Load (AC-15)	—	1.5A	0.75A
		DC	Resistive Load (DC-12)	2.5A	1.1A	0.55A
			Inductive Load (DC-13)	2.3A	0.55A	0.27A
Contact Configuration		3-position Switch	2 contacts			
		Return Monitor Switch	0 to 2 contacts			
		Depress Monitor Switch	0 to 2 contacts			

• Minimum applicable load (reference value): 3V AC/DC, 5 mA (monitor switch), 5V AC/DC, 1 mA (3-position switch)
(Applicable range is subject to the operation conditions and load.)

- APEM
- Switches & Pilot Lights
- Control Boxes
- Emergency Stop Switches
- Enabling Switches
- Safety Products
- Explosion Proof
- Terminal Blocks
- Relays & Sockets
- Circuit Protectors
- Power Supplies
- LED Illumination
- Controllers
- Operator Interfaces
- Sensors
- AUTO-ID
- HE1B
- HE2B
- HE3B
- HE5B
- HE6B
- HE2G
- HE1G-L
- Actuator w/ Plastic Holder

HE2B Double Three-position Enabling Switches

Specifications

Applicable Standards	IEC/EN60947-5-8 (TÜV approval), IEC/EN60947-5-1 UL508 (UL recognized), CSA C22.2 No. 14 (c-UL recognized), GB14048.5 (CCC approval)
Applicable Standards for Use	ISO12100-1, -2/EN12100-1, -2, IEC60204-1/EN60204-1, ISO11161/prEN11161 ISO10218/EN775, ANSI/RIA R15.06, ANSI B11.19
Operating Temperature	-25 to +60°C (no freezing) (without rubber boot, with silicon rubber boot) -10 to +60°C (no freezing) (with NBR/PVC polyblend rubber boot)
Relative Humidity	45 to 85% RH (no condensation)
Storage Temperature	-40 to +80°C (no freezing)
Pollution Degree	2 (inside panel, terminal side) 3 (outside panel, operator side)
Contact Resistance	50 mΩ maximum (initial value)
Insulation Resistance	Between live and dead metal parts: 100 MΩ minimum (500V DC megger) Between terminals of different poles: 100 MΩ minimum (500V DC megger)
Impulse Withstand Voltage	2.5 kV
Operating Frequency	1,200 operations per hour
Mechanical Durability	Position 1 → 2 → 1: 1,000,000 operations minimum Position 1 → 2 → 3 → 1: 100,000 operations minimum
Electrical Durability	100,000 operations minimum
Shock Resistance	Operating extremes: 150 m/s ² Damage limits: 1,000 m/s ²
Vibration Resistance	Operating extremes: 5 to 55 Hz, amplitude 0.5 mm Damage limits: 16.7 Hz, amplitude 1.5 mm
Terminal Style	Solder terminal
Applicable Wire	1 cable, 0.5 mm ² maximum
Terminal Soldering Heat Resistance	310 to 350 °C, 3 seconds maximum
Terminal Tensile Strength	20N minimum
Mounting Screw Recommended Tightening Torque	0.5 to 0.8 N·m
Degree of Protection	IP40 (without rubber boot) IP65 (with rubber boot) (IEC 60529)
Conditional Short-circuit Current	50A (250V) (Use 250V/10A fast-blow fuse for short-circuit protection.)
Direct Opening Force	60N minimum (monitor switch)
Direct Opening Action Stroke	1.7mm minimum (return monitor switch), 4.7mm minimum (depress monitor switch)
Operator Strength	500N minimum (when pressing the entire button surface)
Weight (approx.)	26g (without rubber boot) 30g (with rubber boot)

Operation Characteristics

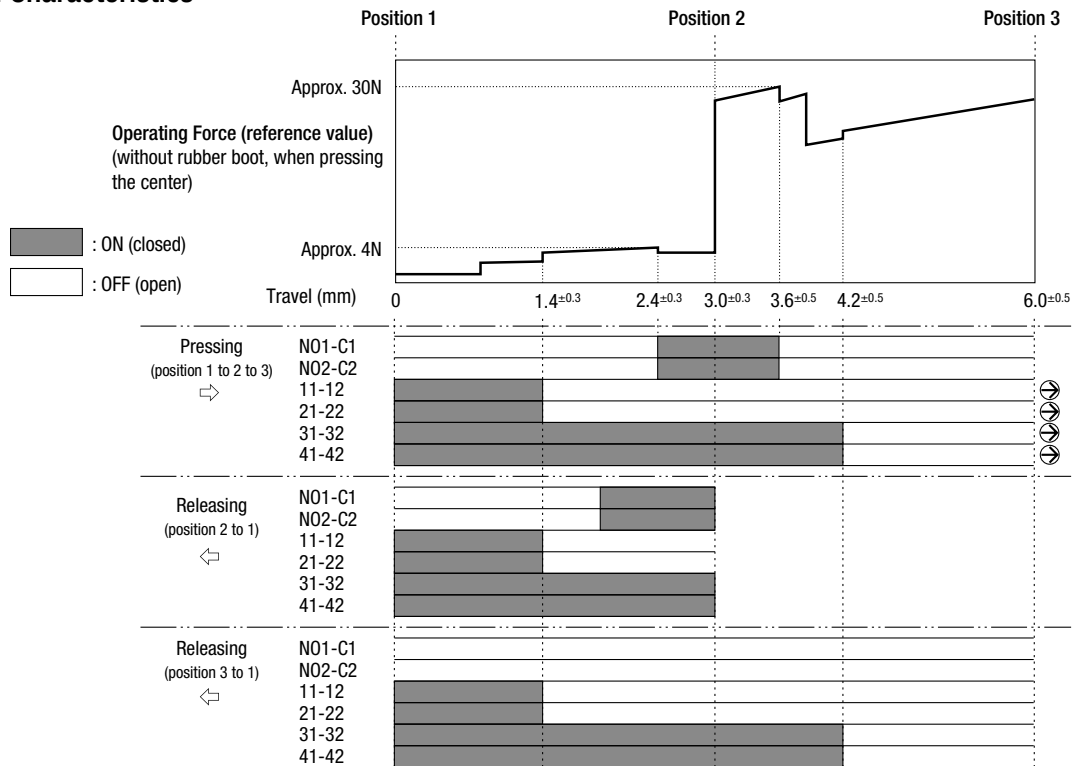

Notes:

- When a rubber boot is used, the operating force depends on the operating temperature.
- The operating force to shift the switch from position 2 to position 3 can be changed. For details, contact IDEC.

Terminal Arrangement (Bottom View)

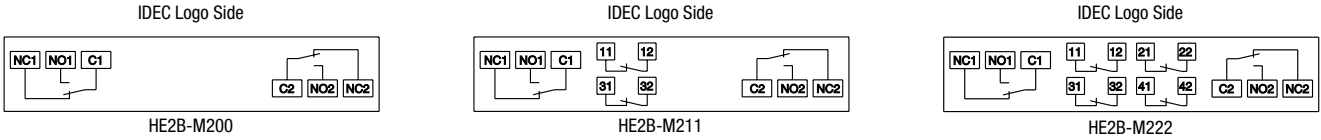

- 3-position switch (note): 2 contacts, terminal nos. between NO1 – C1, NO2 – C2
 - Button return monitor switch: 0 to 2 contacts, terminal nos. between 11 – 12, 21 – 22
 - Button depress monitor switch: 0 to 2 contacts, terminal nos. between 31 – 32, 41 – 42
- Note: Use NO and C terminals for OFF → ON → OFF 3-position switch (NC terminal is not used).

Dimensions

Without Rubber Boot

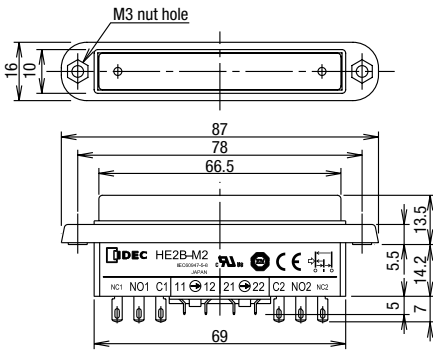

- M3 nuts are supplied with the HE2B enabling switch.

With Rubber Boot

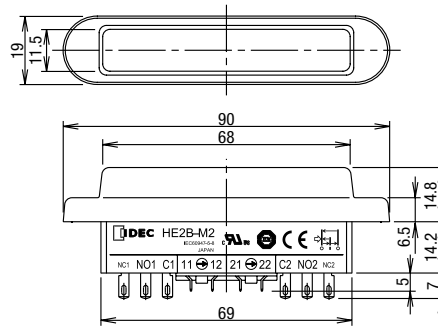

- M3 nuts are installed in the rubber boot.

Mounting Hole Layout

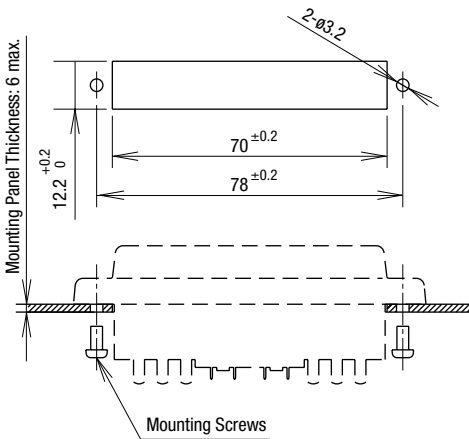

- Mounting screw: Two M3 screws
- Length of mounting screw: Mounting panel thickness + 4 to 5 mm

All dimensions in mm.

Accessories

Replacement Rubber Boot

Material	Color	Part No.	Package Quantity
Silicon Rubber	Y: yellow	HE9Z-D2*	10
	B: black		
NBR/PVC Polyblend	Gray	HE9Z-D2N1	

Note: Specify a rubber boot color code in place of * in the Ordering No.

- Can be installed on HE2B-M200/M211/M222 (without rubber boot)



- APEM
- Switches & Pilot Lights
- Control Boxes
- Emergency Stop Switches
- Enabling Switches
- Safety Products
- Explosion Proof
- Terminal Blocks
- Relays & Sockets
- Circuit Protectors
- Power Supplies
- LED Illumination
- Controllers
- Operator Interfaces
- Sensors
- AUTO-ID

- HE1B
- HE2B
- HE3B
- HE5B
- HE6B
- HE2G
- HE1G-L
- Actuator w/ Plastic Holder

HE2B Double Three-position Enabling Switches

Safety Precautions

- The enabling switches have been designed for industrial purposes. Use for residential, commercial, or lighting purposes may cause unwanted electromagnetic disturbances in which case the user may be required to take adequate mitigation measures. (IEC60947-1, Clause 5.3)
- In order to avoid electric shock or fire, turn the power off before installation, removal, wiring, maintenance, or inspection of the enabling switch.
- Do not assemble or modify the enabling switches and do not disable the enabling function. Otherwise, failure of accidents may occur.
- When using the enabling switch in a safety related part of a control system, use the enabling switch properly in accordance with the safety standards and regulations of the actual machine, system, and application, of the country or region where the enabling switch is used. Also, perform a risk assessment before using the enabling switch.
- Do not disable the safety function of the enabling switch by using tape, elastic band, or by disfiguring the rubber boot, otherwise the loss of enabling switch function may cause serious accidents.
- Perform a risk assessment in actual applications as strong force may be applied to the switch when depressed to position 3.
- Perform a risk assessment for the shape and structure of the part where the enabling switch is installed, to prevent unintended operation of the enabling switch. For example, an enabling switch protruding from the teach pendant may result in an unintended operation of the enabling switch.
- Strong force may be applied to a 3-position enabling switch when pressed to position 3. Provide sufficient strength to the part where 3-position enabling switches will be installed.
- Use wires of the proper size to meet voltage and current requirements, and solder the wires correctly according to the wiring instruction described below. If soldering is incomplete, the wire may heat during operation, causing a fire hazard.
- Do not apply excessive force to the enabling switch.
- Follow the wiring instructions mentioned in the instruction manual.

Instructions

Operating Instructions

- The enabling switch permits machine operation only while the enabling switch is manually operated for robot teaching or other purposes in hazardous areas. Make sure that the control system is designed to activate the machine only when the enabling switch is at position 2 (2.2mm) operating travel.
- To achieve a high level of safety, connect the two contacts of the 3-position switch to a disparity detection circuit (e.g., safety relay module) (ISO 13849-1, EN 954-1).
- Because two contacts are designed to operate independently, pressing the edge of a button turns on one contact earlier than the other contact, causing a delay in operation. To avoid this, always press the center of the button.
- The ridge on the bottom of rubber boot serves as a seal, and waterproof characteristics are attained when the ridge is tightly pressed to the mounting panel. When the mounting panel is bent and the ridge cannot be pressed to the panel, add a reinforcing rib to secure the boot to the mounting panel.
- The edge of rubber boot may stick out if excessive force is applied on the rubber boot. When such event is anticipated, it is recommended to embed the rubber boot in the mounting panel as shown in the figure below.

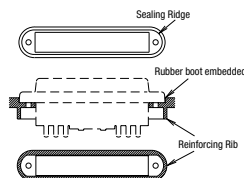

- To prevent malfunction of enabling switches without rubber boot, add extra protection.

Installation Instructions

- Provide sufficient strength to the mounting panel. Insufficient strength of the mounting panel or excessive operating force may damage the enabling switch, resulting in electric shock or fire.

Wiring Instructions

- Applicable wire size: 0.5 mm² maximum × 1 pc.
- Solder the terminal at a temperature of 310 to 350°C within 3 seconds using a soldering iron. Sn-Ag-Cu type is recommended when using lead-free solder. Do not use flow or dip soldering.
- When soldering, take care not to touch the enabling switch with the soldering iron. Also ensure that no tensile force is applied to the terminal. Do not bend the terminal or apply excessive force to the terminal.
- Use non-corrosive liquid rosin as soldering flux.

HE3B ø16mm Rectangular Three-position Enabling Switches

Rectangular operator part with ø16 mm mounting for easy installation.

2-contact 3-position enabling switches ideal for installing in small teach pendants.



• See website for details on approvals and standards.

HE3B

Shape	Style	Contact Configuration	Part No.	Package Quantity	
	Without Rubber Boot	2 contacts (3-position switch)	HE3B-M2	10	
	With Rubber Boot		Rubber Boot Material: Silicon Rubber Color: Y: yellow, B: black	HE3B-M2P*	10
			Rubber Boot Material: NBR/PVC Polyblend Color: gray	HE3B-M2PN1	10

Note: Specify a rubber boot color code in place of * in the Ordering No.

Contact Ratings

Rated Insulation Voltage (Ui)		125V	
Rated Thermal Current (Ith)		3A	
Rated Voltage (Ue)		30V	125V
Rated Current (Ie)	AC	Resistive Load (AC-12)	1A
		Inductive Load (AC-15)	0.7A
	DC	Resistive Load (DC-12)	0.2A
		Inductive Load (DC-13)	0.1A
Contact Configuration (3-position switch)		2 contacts	

Minimum applicable load (reference value): 5V AC/DC, 1 mA
(Applicable range is subject to the operating conditions and load.)

Specifications

Applicable Standards	IEC/EN60947-5-8 (TUV approval), IEC/EN60947-5-1, JIS C8201-5-1 UL508 (UL recognized), CSA C22.2 No. 14 (c-UL recognized), GB14048.5 (CCC approval)
Applicable Standards for Use	ISO12100-1, -2/EN12100-1, -2, IEC60204-1/EN60204-1 ISO11161/prEN11161, ISO10218/EN775, ANSI/RIA R15.06, ANSI B11.19, ISO13849-1 / EN ISO13849-1
Operating Temperature	-25 to +60°C (no freezing) (without rubber boot, with silicon rubber boot) -10 to +60°C (no freezing) (with NBR/PVC polyblend rubber boot)
Relative Humidity	45 to 85% (no condensation)
Storage Temperature	-40 to +80°C (no freezing)
Pollution Degree	2 (inside panel, terminal side) 3 (outside panel, operator side)
Contact Resistance	50 mΩ maximum (initial value)
Insulation Resistance	Between live and dead metal parts: 100 MΩ minimum (500V DC megger) Between terminals of different poles: 100 MΩ minimum (500V DC megger)
Impulse Withstand Voltage	1.5 kV
Operating Frequency	1,200 operations per hour
Mechanical Durability	Position 1 → 2 → 1: 1,000,000 operations minimum Position 1 → 2 → 3 → 1: 100,000 operations minimum
Electrical Durability	100,000 operations minimum
Shock Resistance	Operating extremes: 150 m/s ² Damage limits: 500 m/s ²
Vibration Resistance	Operating extremes: 5 to 55 Hz, amplitude 0.5 mm Damage limits: 16.7 Hz, amplitude 1.5 mm
Terminal Style	Solder terminal
Applicable Wire	1 cable, 0.5 mm ² maximum
Terminal Soldering Heat Resistance	310 to 350°C, 3 seconds maximum
Terminal Tensile Strength	20N minimum
Locking Ring Recommended Tightening Torque	0.68 to 0.88 N·m
Degree of Protection	IP40 (without rubber boot) IP65 (with rubber boot) (IEC 60529)
Conditional Short-circuit Current	50A (250V) (Use 250V/10A fast-blow fuse for short-circuit protection.)
Operator Strength	500N minimum (pressing the entire operator surface)
Weight (approx.)	14g (without rubber boot) 18g (with rubber boot)

APEM

Switches & Pilot Lights

Control Boxes

Emergency Stop Switches

Enabling Switches

Safety Products

Explosion Proof

Terminal Blocks

Relays & Sockets

Circuit Protectors

Power Supplies

LED Illumination

Controllers

Operator Interfaces

Sensors

AUTO-ID

HE1B

HE2B

HE3B

HE5B

HE6B

HE2G

HE1G-L

Actuator w/
Plastic Holder

HE3B ϕ 16mm Rectangular Three-position Enabling Switches

Operation Characteristics

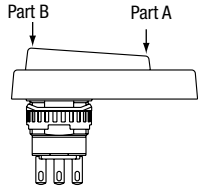

Part A: Approx. 56N
Part B: Approx. 14N

Part A: Approx. 50N
Part B: Approx. 12N

Operating Force (reference value)
(without rubber boot)
(when part A or B is pressed)

■ : ON (closed)
□ : OFF (open)

Part A: Approx. 10N
Part B: Approx. 2N

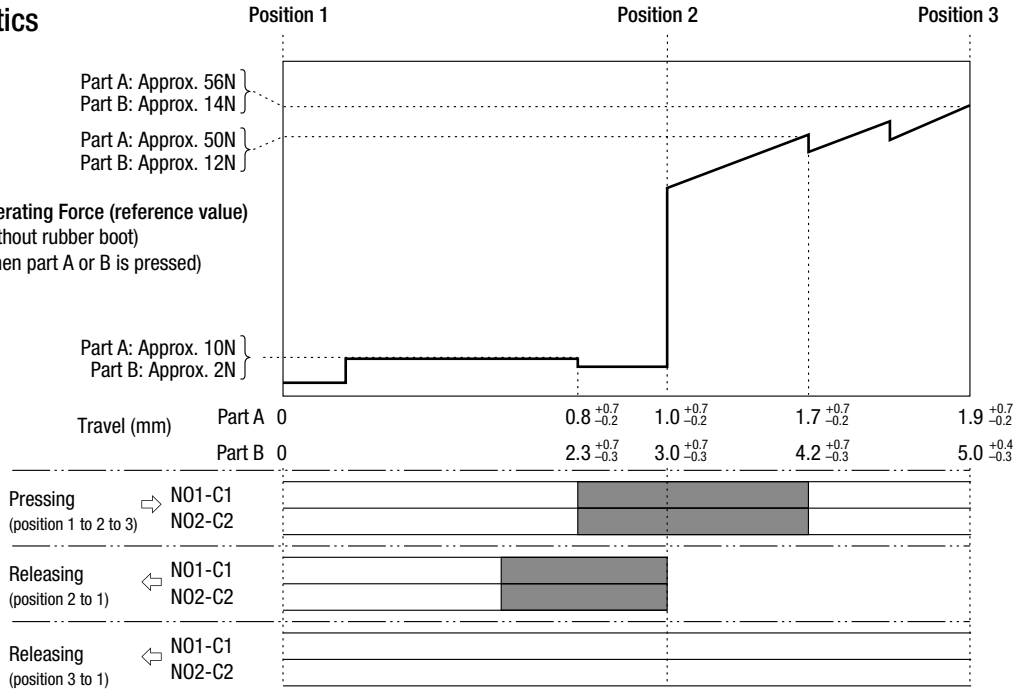

Notes:

- When rubber boot is used, operating force depends on the operating temperature.
- The operating force to shift the switch from position 2 to position 3 can be changed. For details, contact IDEC.

Terminal Arrangement (Bottom View)

• 3-position switch (Note)
2 contacts
Terminal No.: between NO1 and C1, between NO2 and C2
Note: Use NO and C terminals for the 3-position switch of OFF → ON → OFF operation (NC terminal is not used).

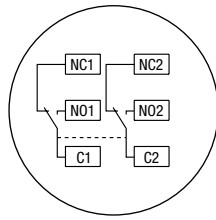

Mounting Hole Layout

- Recommended tightening torque for locking ring: 0.68 to 0.88 N·m
- Use the locking ring wrench MT-001 for tightening.
- Note: To maintain waterproof property of the switch, do not drill through the anti-rotation hole in the mounting panel. When not providing a hole, cut off the anti-rotation projection from the rubber boot. When cutting off the projection, ensure not to make a hole in the rubber boot.

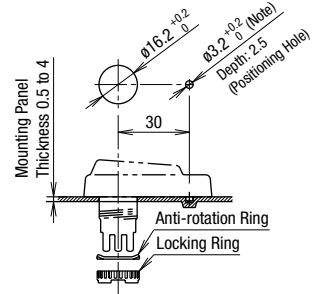

Dimensions

Without Rubber Boot

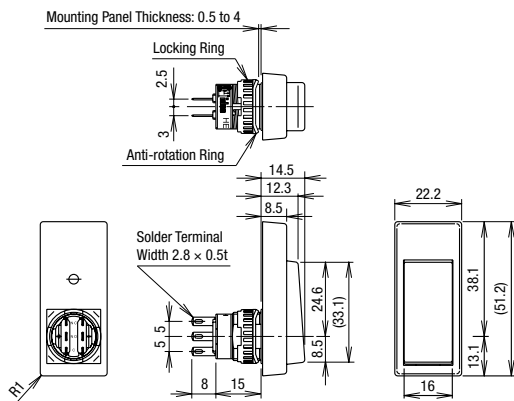

With Rubber Boot

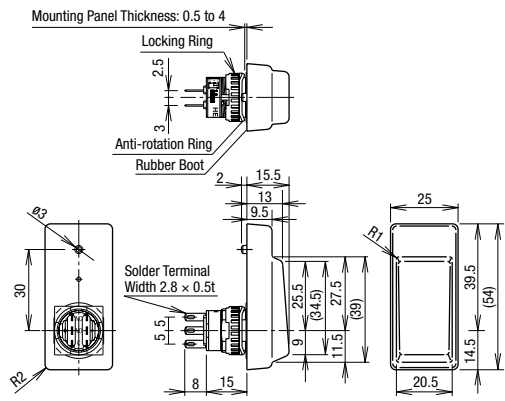

All dimensions in mm.

Accessories

Replacement Rubber Boot

Material	Color	Part No.	Package Quantity
Silicon Rubber	Y: yellow B: black	HE9Z-D3*	10
NBR/PVC Polyblend	Gray	HE9Z-D3N1	

- Specify a rubber boot color code in place of * in the Ordering No.
- Can be installed on HE3B-M2 (without rubber boot).

Locking Ring Wrench

Part No: MT-001
Material: Metal



APEM
Switches & Pilot Lights
Control Boxes
Emergency Stop Switches
Enabling Switches
Safety Products
Explosion Proof
Terminal Blocks
Relays & Sockets
Circuit Protectors
Power Supplies
LED Illumination
Controllers
Operator Interfaces
Sensors
AUTO-ID
HE1B
HE2B
HE3B
HE5B
HE6B
HE2G
HE1G-L
Actuator w/ Plastic Holder

⚠ Safety Precautions

- The enabling switches have been designed for industrial purposes. Use for residential, commercial, or lighting purposes may cause unwanted electromagnetic disturbances in which case the user may be required to take adequate mitigation measures. (IEC60947-1, Clause 5.3)
- Do not assemble or modify the enabling switches and do not disable the enabling function. Otherwise, failure of accidents may occur.
- When using the enabling switch in a safety related part of a control system, use the enabling switch properly in accordance with the safety standards and regulations of the actual machine, system, and application, of the country or region where the enabling switch is used. Also, perform a risk assessment before using the enabling switch.
- Do not disable the safety function of the enabling switch by using tape, elastic band, or by disfiguring the rubber boot, otherwise the loss of enabling switch function may cause serious accidents.
- Perform a risk assessment in actual applications as strong force may be applied to the switch when depressed to position 3.
- Perform a risk assessment for the shape and structure of the part where the enabling switch is installed, to prevent unintended operation of the enabling switch. For example, an enabling switch protruding from the teach pendant may result in an unintended operation of the enabling switch.
- Strong force may be applied to a 3-position enabling switch when pressed to position 3. Provide sufficient strength to the part where 3-position enabling switches will be installed.
- Use wires of the proper size to meet voltage and current requirements, and solder the wires correctly according to the wiring instruction described below. If soldering is incomplete, the wire may heat during operation, causing a fire hazard.
- Do not apply excessive force to the enabling switch.
- Follow the wiring instructions mentioned in the instruction manual.

Instructions

Operating Instructions

- The enabling switch permits machine operation only while the enabling switch is manually operated for robot teaching or other purposes in hazardous areas. Make sure that the control system is designed to activate the machine only when the enabling switch is at position 2 (3mm) operating travel.
- To achieve a high level of safety, connect the two contacts of the 3-position switch to a disparity detection circuit (e.g., safety relay module) (ISO 13849-1, EN 954-1).
- Because two contacts are designed to operate independently, pressing the edge of a button turns on one contact earlier than the other contact, causing a delay in operation. To avoid this, always press the center of the button.
- When an enabling switch with rubber boot is mounted in a hermetically-sealed control box, a large change in internal air pressure may cause the rubber boot to inflate and deflate, affecting the performance of the enabling switch. Check periodically to make sure that the enabling switch operates correctly.
- The edge of rubber boot may stick out if excessive force is applied on the rubber boot. When such event is anticipated, it is recommended to embed the rubber boot in the mounting panel as shown in the figure below.
- To prevent malfunction of enabling switches without rubber boot, add extra protection.

Installation Instructions

- If the mounting panel is deformed, waterproof characteristics of the enabling switch with rubber boot cannot be achieved. Keep sufficient strength on the mounting panel.
- The rubber boot has a projection for positioning the enabling switch onto the mounting panel. To maintain waterproof characteristics of the switch, do not drill through the anti-rotation hole in the mounting panel. When not providing the hole, remove the anti-rotation projection from the rubber boot. When removing the projection, ensure not to make a hole in the rubber boot.
- Secure the flange part when tightening the locking ring so that the enabling switch does not rotate. When the enabling switch may rotate during operation, it is recommended to embed the switch in the mounting panel as shown below.

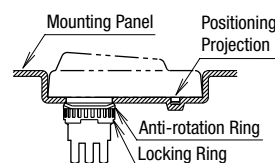

Wiring Instructions

- Applicable wire size: 0.5 mm² maximum × 1 pc.
- Solder the terminal at a temperature of 310 to 350°C within 3 seconds using a soldering iron. Sn-Ag-Cu type is recommended when using lead-free solder. Do not use flow or dip soldering.
- When soldering, take care not to touch the enabling switch with the soldering iron. Also ensure that no tensile force is applied to the terminal. Do not bend the terminal or apply excessive force to the terminal.
- Use non-corrosive liquid rosin as soldering flux.

HE5B ø16mm Round Three-position Enabling Switches

Round-shaped operator for ø16 mm mounting hole.

3-position enabling switch with two contacts, ideal for installing in small teaching pendants.



• See website for details on approvals and standards.

HE5B

Shape	Style	Contact Configuration	Part No.	Package Quantity
	Silicon Rubber Y: yellow B: black	2 contacts (3-position switch)	HE5B-M2P*	10
	NBR/PVC		HE5B-M2PN1	10

• Specify a rubber boot color code in place of * in the Ordering No.

Contact Ratings

Rated Insulation Voltage (Ui)		125V	
Rated Thermal Current (Ith)		3A	
Rated Voltage (Ue)		30V	125V
Rated Current (Ie)	AC	Resistive Load (AC-12)	0.5A
		Inductive Load (AC-15)	0.3A
	DC	Resistive Load (DC-12)	1A
		Inductive Load (DC-13)	0.7A
Contact Configuration (3-position switch)		2 contacts	

Minimum applicable load (reference): 3V AC/DC, 1mA
 (Applicable operation area depends on the operating conditions and load.)

Specifications

Applicable Standards	IEC/EN60947-5-8 (TUV approval), IEC/EN60947-5-1 UL508 (UL recognized), CSA C22.2 No. 14 (c-UL recognized), GB14048.5 (CCC approval)
Applicable Standards for Use	ISO12100-1, -2/EN12100-1, -2, IEC60204-1/EN60204-1 ISO11161/prEN11161, ISO10218/EN775, ANSI/RIA R15.06, ANSI B11.19
Operating Temperature	Silicon rubber boot: -25 to 60°C (no freezing) NBR/PVC Polyblend rubber boot: -10 to 60°C (no freezing)
Relative Humidity	45 to 85% (no condensation)
Storage Temperature	-40 to +80°C (no freezing)
Pollution Degree	2 (inside panel, terminal side) 3 (outside panel, operator side)
Contact Resistance	50 mΩ maximum (initial value)
Insulation Resistance	Between live and dead metal parts: 100 MΩ minimum (500V DC megger) Between terminals of different pole: 100 MΩ minimum (500V DC megger)
Impulse Withstand Voltage	1.5 kV
Operating Frequency	1,200 operations per hour
Mechanical Durability	Position 1 → 2 → 1: 1,000,000 operations minimum Position 1 → 2 → 3 → 1: 100,000 operations minimum
Electrical Durability	100,000 operations minimum
Shock Resistance	Operating extremes: 150 m/s ² Damage limits: 500 m/s ²
Vibration Resistance	Operating extremes: 5 to 55 Hz, amplitude 0.5 mm Damage limits: 5 to 55 Hz, amplitude 1.5 mm
Terminal Style	Solder terminal
Applicable Wire	0.5 mm ² maximum per line
Terminal Soldering Heat Resistance	310 to 350°C, 3 seconds maximum
Terminal Tensile Strength	20 N minimum
Locking Ring Recommended Tightening Torque	0.29 to 0.49 N·m
Degree of Protection	IP65 (IEC 60529)
Conditional Short-circuit Current	50A (125V) (Use 250V/10A fast-blow fuse for short circuit protection.)
Operator Strength	250N minimum (when pressing the entire operator surface)
Weight (approx.)	8g (without rubber boot), 9g (with rubber boot)

Operating Characteristics

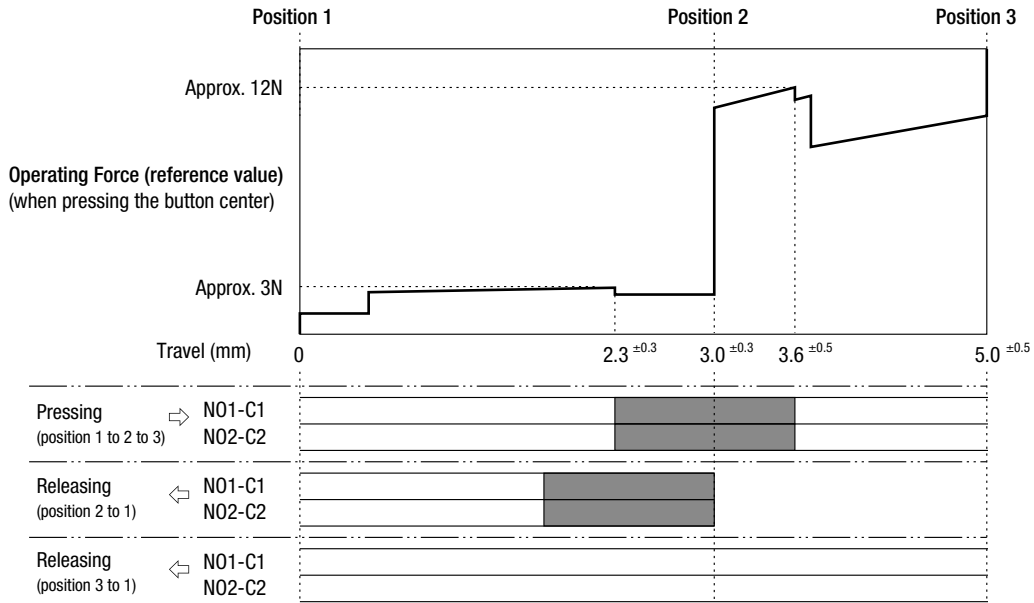

Notes:

- Operating force depends on ambient temperature.
- The operating force to shift the switch from position 2 to position 3 can be changed. For details, consult IDEC.

Terminal Arrangement (Bottom View)

- 3-position switch (Note)
- 2 contacts
- Terminal No.: between NO1 and C1, NO2 and C2
- Note: For OFF → ON → OFF 3-position switches, use NO and C terminals (NC terminal is not used).

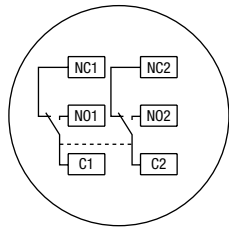

Mounting Hole Layout

- Recommended Tightening Torque for Locking Ring: 0.29 to 0.49 N·m
- Use the MT-001 locking ring wrench for tightening.

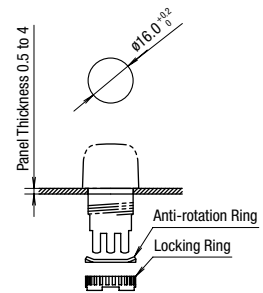

Dimensions

With Rubber Boot

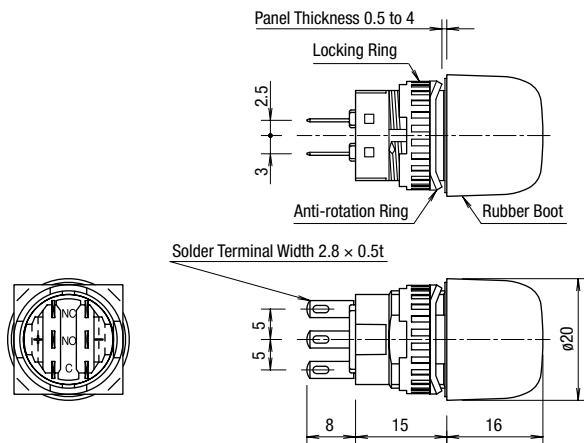

All dimensions in mm.

Accessories

Replacement Rubber Boot

Rubber Boot Material	Color	Part No.	Package Quantity
Silicon Rubber	B: black Y: yellow	HE9Z-D5*	10
NBR/PVC Polyblend	Gray	HE9Z-D5N1	

- Specify a rubber boot color code in place of * in the Ordering No.



Locking Ring Wrench
Part No: MT-001
Material: Metal



- APEM
- Switches & Pilot Lights
- Control Boxes
- Emergency Stop Switches
- Enabling Switches
- Safety Products
- Explosion Proof
- Terminal Blocks
- Relays & Sockets
- Circuit Protectors
- Power Supplies
- LED Illumination
- Controllers
- Operator Interfaces
- Sensors
- AUTO-ID
- HE1B
- HE2B
- HE3B
- HE5B
- HE6B
- HE2G
- HE1G-L
- Actuator w/ Plastic Holder

HE5B ø16mm Round Three-position Enabling Switches

Grip Style Enabling Switch Housing

HE5B enabling switches can be installed in the HE9Z-GSH51 grip style enabling switch housing to be used as 3-position grip style enabling switches.

Part No.	Ordering No.	Package Quantity
HE9Z-GSH51	HE9Z-GSH51	1

Specifications

Applicable Standards	IEC/EN 60529 UL50
Operating Temperature	-25 to 60°C (no freezing)
Relative Humidity	45 to 85% RH (no condensation)
Storage Temperature	-40 to 80°C (no freezing)
Pollution Degree	3
Shock Resistance	Damage limits: 500 m/s ²
Vibration Resistance	Damage limits: 5 to 55 Hz, amplitude 0.5 mm
Electric Shock Protection Class	Class II (when using HE5B-M2P*)
Applicable Cable	Outside diameter ø4.5 to 10 mm
Conduit Port Size	M16 (cable gland is supplied with the grip style enabling switch housing)
Degree of Protection	IP65 (with HE5B-M2P*) NEMA type 4X indoor use only (with HE5B-M2P*)
Weight (approx.)	65g (grip style enabling switch housing only)

- The above specifications are for the grip style enabling switch housing only. For enabling switch, see the HE5B specifications on **D-075**
- The following switches can be installed on the grip style enabling switch housing to be used as hand-held switches.
 - AB6M pushbuttons (IP65, except for AB6M-V)
 - AS6M selector switches (IP65)
 - AS6M key selector switches (IP65)

Dimensions

HE9Z-GSH51

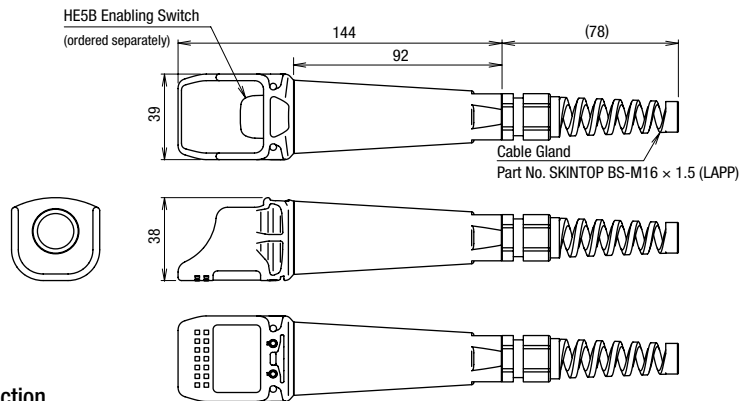

HE9Z-GSH51 + HE5B Construction

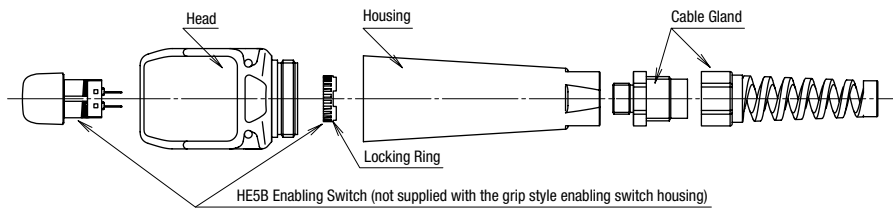

- Anti-rotation ring is not required when installing the HE5B enabling switch on the HE9Z-GSH51 grip style enabling switch housing. Use the locking ring only.

Mounting Bracket

Part No: HE9Z-GH1

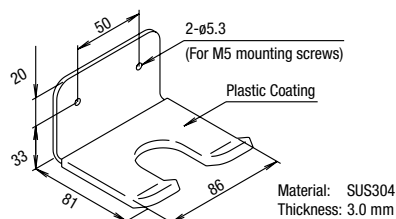

All dimensions in mm.



Notes:

- The HE9Z-GSH51 grip style enabling switch housing does not include the HE5B enabling switch. The enabling switch must be ordered separately.
- The HE5B enabling switch must be installed and wired to the HE9Z-GSH51 grip style enabling switch housing by the user. For information on wiring, see the instruction sheet supplied with the HE9Z-GSH51.

Safety Precautions

- The enabling switches have been designed for industrial purposes. Use for residential, commercial, or lighting purposes may cause unwanted electromagnetic disturbances in which case the user may be required to take adequate mitigation measures. (IEC60947-1, Clause 5.3)
- Do not assemble or modify the enabling switches and do not disable the enabling function. Otherwise, failure of accidents may occur.
- When using the enabling switch in a safety related part of a control system, use the enabling switch properly in accordance with the safety standards and regulations of the actual machine, system, and application, of the country or region where the enabling switch is used. Also, perform a risk assessment before using the enabling switch.
- Do not disable the safety function of the enabling switch by using tape, elastic band, or by disfiguring the rubber boot, otherwise the loss of enabling switch function may cause serious accidents.
- Perform a risk assessment in actual applications as strong force may be applied to the switch when depressed to position 3.
- Perform a risk assessment for the shape and structure of the part where the enabling switch is installed, to prevent unintended operation of the enabling switch. For example, an enabling switch protruding from the teach pendant may result in an unintended operation of the enabling switch.
- Strong force may be applied to a 3-position enabling switch when pressed to position 3. Provide sufficient strength to the part where 3-position enabling switches will be installed.
- Operator strength is 250N. If the expected operating force exceeds 250N, use a separate actuator with a stopper.
- Use wires of the proper size to meet voltage and current requirements, and solder the wires correctly according to the wiring instruction described below. If soldering is incomplete, the wire may heat during operation, causing a fire hazard.
- Do not apply excessive force to the enabling switch.
- Follow the wiring instructions mentioned in the instruction manual.

Instructions

Operating Instructions

- The enabling switch permits machine operation only while the enabling switch is manually operated for robot teaching or other purposes in hazardous areas. Make sure that the control system is designed to activate the machine only when the enabling switch is at position 2 (3mm) operating travel.
- To achieve a high level of safety, connect the two contacts of the 3-position switch to a disparity detection circuit (e.g., safety relay module) (ISO 13849-1, EN 954-1).
- Because two contacts are designed to operate independently, pressing the edge of a button turns on one contact earlier than the other contact, causing a delay in operation. To avoid this, always press the center of the button.
- When an enabling switch with rubber boot is mounted in a hermetically-sealed control box, a large change in internal air pressure may cause the rubber boot to inflate and deflate, affecting the performance of the enabling switch. Check periodically to make sure that the enabling switch operates correctly.
- The edge of rubber boot may stick out if excessive force is applied on the rubber boot. When such event is anticipated, it is recommended to embed the rubber boot in the mounting panel as shown in the figure below.
- To prevent malfunction of enabling switches without rubber boot, add extra protection.

Installation Instructions

- If the mounting panel is deformed, waterproof characteristics of the enabling switch with rubber boot cannot be achieved. Keep sufficient strength on the mounting panel.

HE9Z-GSH51 Grip Style Enabling Switch Housing

- Recommended Tightening Torque

Parts for tightening	Torque
A Head and body	0.8 to 1.2 N·m
B Body and cable gland	2.7 ± 3.3 N·m
C Cable gland	2.7 ± 3.3 N·m

- The recommended tightening torques of B and C are for the supplied cable gland. When using another cable gland, refer to the tightening torque of the cable gland used.

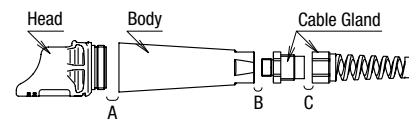

Wiring Instructions

- Applicable wire size: 0.5 mm² maximum × 1 pc.
- Solder the terminal at a temperature of 310 to 350°C within 3 seconds using a soldering iron. Sn-Ag-Cu type is recommended when using lead-free solder. Do not use flow or dip soldering.
- When soldering, take care not to touch the enabling switch with the soldering iron. Also ensure that no tensile force is applied to the terminal. Do not bend the terminal or apply excessive force to the terminal.
- Use non-corrosive liquid rosin as soldering flux.

APEM

Switches & Pilot Lights

Control Boxes

Emergency Stop Switches

Enabling Switches

Safety Products

Explosion Proof

Terminal Blocks

Relays & Sockets

Circuit Protectors

Power Supplies

LED Illumination

Controllers

Operator Interfaces

Sensors

AUTO-ID

HE1B

HE2B

HE3B

HE5B

HE6B

HE2G

HE1G-L

Actuator w/ Plastic Holder

HE6B Rectangular Three-position Enabling Switches

3-position enabling switch with monitoring contacts—Smallest in its class.



• See website for details on approvals and standards.

HE6B

	Style	Contact Configuration/No. of Contacts			Part No.	Package Quantity
		3-position Switch	Return Monitor Switch	Depress Monitor Switch		
	With Rubber Boot Rubber Boot Material: Silicon Rubber Color: Y: yellow B: black	2	0	0	HE6B-M200*	10
		2	1	1	HE6B-M211*	10

• Specify rubber boot color code in place of * in the Part No.

Part No. Development

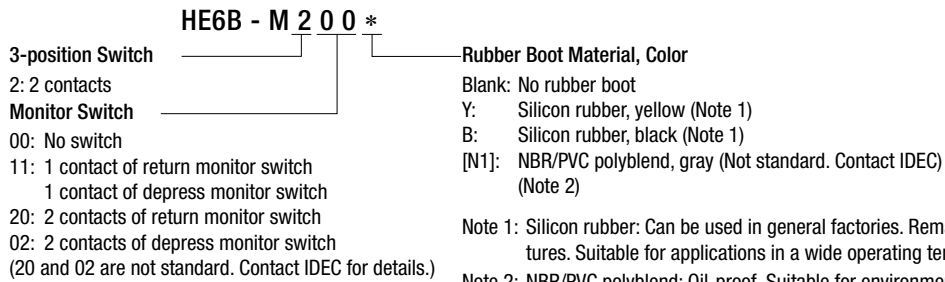

Note 1: Silicon rubber: Can be used in general factories. Remaining flexible in cold temperatures. Suitable for applications in a wide operating temperature range.

Note 2: NBR/PVC polyblend: Oil-proof. Suitable for environments subjected to machine oil and for painting robots where silicon rubber cannot be used.

- APEM
- Switches & Pilot Lights
- Control Boxes
- Emergency Stop Switches
- Enabling Switches
- Safety Products
- Explosion Proof
- Terminal Blocks
- Relays & Sockets
- Circuit Protectors
- Power Supplies
- LED Illumination
- Controllers
- Operator Interfaces
- Sensors
- AUTO-ID
- HE1B
- HE2B
- HE3B
- HE5B
- HE6B
- HE2G
- HE1G-L
- Actuator w/ Plastic Holder

Specifications

Applicable Standards	IEC/EN60947-5-1 IEC/EN60947-5-8 (TÜV approval) GS-ET-22 (TÜV approval) UL508 (UL recognized) CSA C22.2 No.14 (c-UL recognized) GB14048.5 (CCC approval)
Applicable Standards for Use	ISO12100/EN ISO12100 IEC60204-1/EN60204-1 ISO11161/EN ISO11161 ISO10218-1/EN ISO10218-1 ANSI/RIA/ISO10218-1 ANSI/RIA/R15.06, ANSI B 11.19 ISO13849-1/EN ISO13849-1
Operating Temperature	-25 to +60°C (no freezing)
Relative Humidity	45 to 85% RH (no condensation)
Storage Temperature	-40 to +80°C (no freezing)
Pollution Degree	2 (inside panel, terminal side) 3 (outside panel, operator side)
Contact Resistance	50 mΩ maximum (initial value)
Insulation Resistance	Between live and dead metal parts: 100 MΩ minimum (500V DC megger) Between terminals of different poles: 100 MΩ minimum (500V DC megger)
Impulse Withstand Voltage	1.5 kV (3 position switch) 2.5 kV (monitor switch)
Operating Frequency	1200 operations per hour
Mechanical Durability	Position 1→2→1: 1,000,000 operations minimum Position 1→2→3→1: 100,000 operations minimum
Electrical Durability	100,000 operations minimum (rated load) 1,000,000 operations minimum (24V AC/DC, 100 mA)
Shock Resistance	Operating extremes: 150 m/s ² Damage limits: 500 m/s ²
Vibration Resistance	Operating extremes: 5 to 55 Hz, amplitude 0.5 mm Damage limits: 16.7 Hz, amplitude 1.5 mm
Terminal Style	Solder terminal
Applicable Wire	1 cable, 0.5 mm ² maximum
Solder Terminal Heat Resistance	310 to 350°C, 3 seconds maximum
Terminal Tensile Strength	20N minimum
Locking Ring Recommended Tightening Torque	0.5 to 0.8 N·m
Degree of Protection	IP65 (IEC 60529)
Conditional Short-circuit Current	50A (125V): 3-position switch (Use 120V/10A fast acting type fuse for short circuit protection.) (IEC 60127-1) 50A (250V): monitor switch (Use 250V/10A fast acting type fuse for short circuit protection.) (IEC 60127-1)
Direct Opening Force	40N minimum (monitor switch)
Direct Opening Stroke (when pressing the entire button surface)	0.9 mm minimum (return monitor switch) 4.0 mm minimum (depress monitor switch)
Operator Strength	250N minimum (when pressing the entire button surface)
Weight (approx.)	14g (without rubber boot), 17g (with rubber boot)

Ratings

Rated Insulation Voltage (Ui)		125V (monitor switch: 250V)				
Rated Thermal Current (Ith)		3A				
Rated Voltage (Ue)		30V	125V	250V		
Rated Current (Ie)	3-position switch	AC	Resistive Load (AC-12)	—	0.5A	—
		DC	Resistive Load (DC-12)	1A	—	—
	Return monitor switch	AC	Resistive Load (AC-12)	—	2.5A	1.5A
		DC	Resistive Load (DC-12)	2.5A	1.1A	0.55A
	Depress monitor switch (NC)	AC	Resistive Load (AC-15)	—	1.5A	0.75A
		DC	Resistive Load (DC-13)	2.3A	0.55A	0.27A
Contact Configuration		3-position switch	2 contacts			
		Return monitor switch	0 to 1 contact			
		Depress monitor switch	0 to 1 contact			

- Minimum applicable load (reference value): 3V AC/DC, 5 mA
(Applicable operation area depends on the operating conditions and load.)

TÜV ratings:

3 position switch:
AC-12 125V/0.5A
DC-12 30V/1A
DC-13 30V/0.7A

UL ratings:

3-position switch:
125V AC/0.5A (Resistive)
30V DC/1A (Resistive)
30V DC/0.7A (Pilot Duty)

Monitor Switch:

AC-15 250V/0.75A
DC-13 125V/0.22A
DC-13 30V/2.3A

Monitor switch:

250V AC/0.5A (General use)
30V DC/1A (General use)
250V AC/0.75A (Pilot Duty)
30V DC/2.3A (Pilot Duty)

Operating Characteristics

HE6B-M211

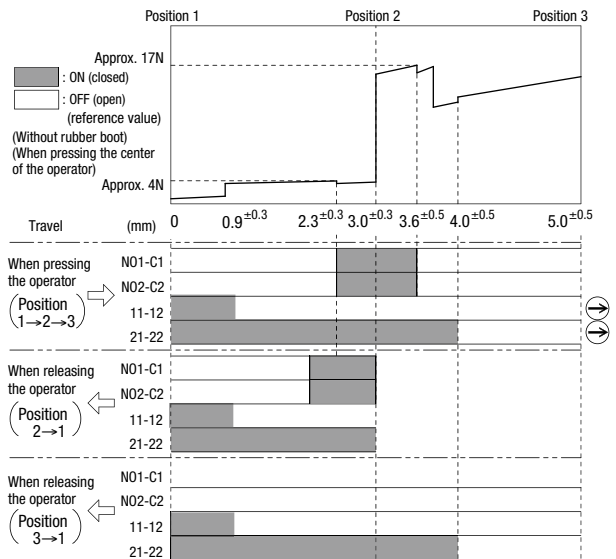

Notes:

- When a rubber boot is used, the operating force depends on the operating temperature.
- The operating force to move the button from position 2 to position 3 can be changed. For details, contact IDEC.

- APEM
- Switches & Pilot Lights
- Control Boxes
- Emergency Stop Switches
- Enabling Switches
- Safety Products
- Explosion Proof
- Terminal Blocks
- Relays & Sockets
- Circuit Protectors
- Power Supplies
- LED Illumination
- Controllers
- Operator Interfaces
- Sensors
- AUTO-ID
- HE1B
- HE2B
- HE3B
- HE5B
- HE6B
- HE2G
- HE1G-L
- Actuator w/ Plastic Holder

HE6B Rectangular Three-position Enabling Switches

Dimensions

All dimensions in mm.

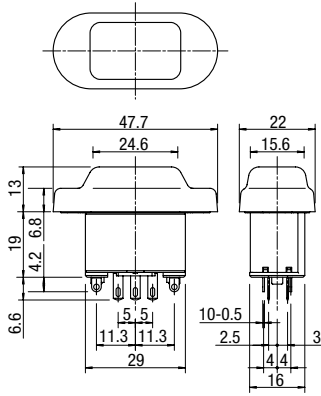

Terminal Arrangement (bottom view)

HE6B-M211

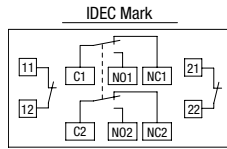

- 3-position switch (Note): 2 contacts
 - Return monitor switch: 1 contact, terminal nos. 11-12
 - Depress monitor switch: 1 contact, terminal nos. 21-22
 - There are no terminal nos. 11-22 and 21-22 for HE6B-M200.
- Note: Use NO and C terminals for OFF → ON → OFF 3-position switch (NC terminal is not used.)

Mounting Hole Layout

All dimensions in mm.

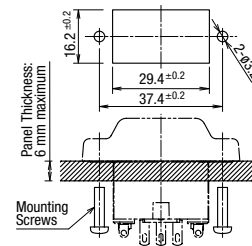

- Mounting screws: M3 screw × 2
(not attached and must be supplied by the user)
- Mounting screw length: 5 to 6 mm (panel thickness + gasket)

Accessories

Replacement Rubber Boot

Material, Color	Part No.	Package Quantity
Silicon Rubber Y: yellow B: black	HE9Z-D6*	10

- Specify rubber boot color code in place of * in the Ordering No.



APEM

Switches & Pilot Lights

Control Boxes

Emergency Stop Switches

Enabling Switches

Safety Products

Explosion Proof

Terminal Blocks

Relays & Sockets

Circuit Protectors

Power Supplies

LED Illumination

Controllers

Operator Interfaces

Sensors

AUTO-ID

HE1B

HE2B

HE3B

HE5B

HE6B

HE2G

HE1G-L

Actuator w/
Plastic Holder

Safety Precautions

- The enabling switches have been designed for industrial purposes. Use for residential, commercial, or lighting purposes may cause unwanted electromagnetic disturbances in which case the user may be required to take adequate mitigation measures. (IEC60947-1, Clause 5.3)
- Do not assemble or modify the enabling switches and do not disable the enabling function. Otherwise, failure of accidents may occur.
- When using the enabling switch in a safety related part of a control system, use the enabling switch properly in accordance with the safety standards and regulations of the actual machine, system, and application, of the country or region where the enabling switch is used. Also, perform a risk assessment before using the enabling switch.
- Do not disable the safety function of the enabling switch by using tape, elastic band, or by disfiguring the rubber boot, otherwise the loss of enabling switch function may cause serious accidents.
- Perform a risk assessment in actual applications as strong force may be applied to the switch when depressed to position 3.
- Perform a risk assessment for the shape and structure of the part where the enabling switch is installed, to prevent unintended opera-

tion of the enabling switch. For example, an enabling switch protruding from the teach pendant may result in an unintended operation of the enabling switch.

- Strong force may be applied to a 3-position enabling switch when pressed to position 3. Provide sufficient strength to the part where 3-position enabling switches will be installed.
- Use wires of the proper size to meet voltage and current requirements, and solder the wires correctly according to the wiring instruction described below. If soldering is incomplete, the wire may heat during operation, causing a fire hazard.
- Do not apply excessive force to the enabling switch.
- Follow the wiring instructions mentioned in the instruction manual.
- If multiple safety components are wired in series, the Performance Level to EN ISO 13849-1 will be reduced due to the restricted error detection under certain circumstance.
- The entire concept of the control system, in which the safety component is integrated, must be validated to EN ISO 13849-2.

Instructions

Operating Instructions

- The enabling switch permits machine operation only while the enabling switch is manually operated for robot teaching or other purposes in hazardous areas. Make sure that the control system is designed to activate the machine only when the enabling switch is at position 2 (3mm) operating travel.
- To achieve a high level of safety, connect the two contacts of the 3-position switch to a disparity detection circuit (e.g., safety relay module) (ISO 13849-1, EN 954-1).
- Because two contacts are designed to operate independently, pressing the edge of a button turns on one contact earlier than the other contact, causing a delay in operation. To avoid this, always press the center of the button.
- When an enabling switch with rubber boot is mounted in a hermetically-sealed control box, a large change in internal air pressure may cause the rubber boot to inflate and deflate, affecting the performance of the enabling switch. Check periodically to make sure that the enabling switch operates correctly.
- If the mounting panel is deformed, waterproof characteristics of the enabling switch with rubber boot cannot be achieved. Keep sufficient strength on the mounting panel.
- The ridge on the bottom of rubber boot serves as a seal, and waterproof characteristics are attained when the ridge is tightly pressed to the mounting panel. When the mounting panel is bent and the ridge cannot be pressed to the panel, add a reinforcing rib to secure the boot to the mounting panel.
- The edge of rubber boot may stick out if excessive force is applied on the rubber boot. When such event is anticipated, it is recommended to embed the rubber boot in the mounting panel as shown in the figure below.

- The edge of rubber boot may stick out if excessive force is applied on the rubber boot. When such event is anticipated, it is recommended to embed the rubber boot in the mounting panel as shown in the figure below.

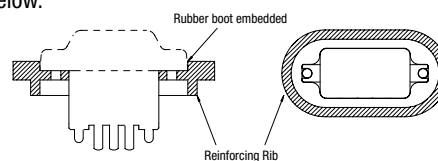

- To prevent malfunction of enabling switches without rubber boot, add extra protection.

Installation Instructions

- If the mounting panel is deformed, waterproof characteristics of the enabling switch cannot be achieved. Keep sufficient strength on the mounting panel.

Wiring Instructions

- Applicable wire size: 0.5 mm² maximum × 1 pc.
- Solder the terminal at a temperature of 310 to 350°C within 3 seconds using a soldering iron. Sn-Ag-Cu type is recommended when using lead-free solder. Do not use flow or dip soldering.
- When soldering, take care not to touch the enabling switch with the soldering iron. Also ensure that no tensile force is applied to the terminal. Do not bend the terminal or apply excessive force to the terminal.
- Use non-corrosive liquid rosin as soldering flux.

Grip Style Three-position Enabling Switches

HE2G



Compact, light-weight grip switch provides a comfortable hold



• See website for details on approvals and standards.

Select from a wide variety of models

Equipped with different control units for various use.

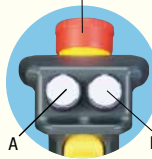
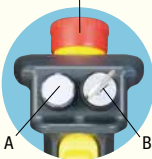
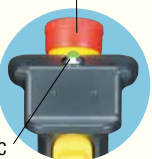
<p>• HE2G-21SHE-L-L Emergency Stop Switch XA1E-BV3U02R</p>  <p>A: Momentary Pushbutton (white) AB6M-M2PLW B: Momentary Pushbutton (white) AB6M-M2PLW</p>	<p>• HE2G-21SHE-L-K Emergency Stop Switch XA1E-BV3U02R</p>  <p>A: Momentary Pushbutton (white) AB6M-M2PLW B: Key Selector AS6M-2KT2PA</p>	<p>• HE2G-21SHE-P-0 Emergency Stop Switch XA1E-BV3U02R</p>  <p>C: Pilot Light (green) UP9P-2498G</p>
--	--	---

Compact design fits comfortably in the hand

The curved grip and small-size makes operation comfortable. The light-weight (approx. 140g, HE2G-21SH) and compact size is suitable for operators with small hands and for use in tight working environments.



3-position switch with distinctive tactile feedback

Tactile clicking feedback allows easy recognition of switch operation when shifting from position 1 (contact OFF) to position 2 (contact ON).

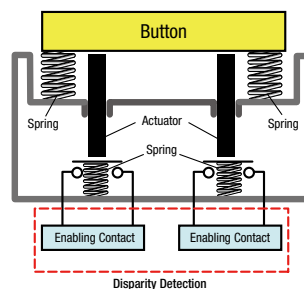

Dual enabling contacts ensure a high level of safety

Dual enabling contacts with a separate actuator for each contact is IDEC's original design. This ensures a higher safety level. Disparity detection of category 4 (ISO 13849-1) can be achieved by using this switch with a safety relay module or a safety controller.





Actuators with plastic holders, applicable for HS5 series interlock switches, can be used with the HE2G

Example of automatic and manual operation modes when HS5D is used

 <p>Automatic mode</p>	 <p>Manual mode</p>	 <p>Actuator with plastic holder (optional) HE9Z-GP15 Handstrap (optional) HG9Z-PS1</p>
--	--	--

Operation modes can be changed by inserting/removing the actuator with plastic holder installed to the HE2G into the HS5D. When the actuator is inserted, the operation is in automatic mode. When the actuator is removed, the operation is in manual mode.

	Model	Page
	HE2G	D-084
	HE1G-L	D-089

- APEM
- Switches & Pilot Lights
- Control Boxes
- Emergency Stop Switches
- Enabling Switches
- Safety Products
- Explosion Proof
- Terminal Blocks
- Relays & Sockets
- Circuit Protectors
- Power Supplies
- LED Illumination
- Controllers
- Operator Interfaces
- Sensors
- AUTO-ID
- HE1B
- HE2B
- HE3B
- HE5B
- HE6B
- HE2G
- HE1G-L
- Actuator w/ Plastic Holder

HE2G Grip Style Three-position Enabling Switches

New compact, light-weight grip style enabling switch provides a comfortable hold



HE2G

3-Position Switch	Monitor Switch	Contact Configuration				Rubber Boot Material / Color	Wiring Style	Part No.
		Emergency Stop Switch	Switch (A)	Switch (B)	Pilot Switch (green) (C)			
2 contacts	With (1NC)	Without				Silicon Rubber / (Yellow) (Note 2)	Solder Terminal	HE2G-21SH
		Without				NBR/PVC Polyblend / (Gray) (Note 3)	Internal Connector	HE2G-21SC
		Without					Solder Terminal	HE2G-21SH-1N
		Without				Silicon Rubber / (Yellow) (Note 2)	Internal Connector	HE2G-21SC-1N
		Without					Solder Terminal	HE2G-21SHE
		With (2NC)	Without		Without	Silicon Rubber / (Yellow) (Note 2)	Solder Terminal	HE2G-21SHE-P-0
		Without	Momentary Pushbutton (DPDT)	Momentary Pushbutton (DPDT)	With		Solder Terminal	HE2G-21SH-L-L
		With (2NC)			Key Selector Switch (DPDT)		Without	Solder Terminal
			Solder Terminal	HE2G-21SCE-L-L				
		Internal Connector	HE2G-21SCE-L-L					
Solder Terminal	HE2G-21SHE-L-K							
Internal Connector	HE2G-21SCE-L-K							

Note 1: Additional switches installed on the HE2G are as follows:

- Emergency Stop Switch: XA1E-BV3U02R
- Momentary Pushbutton: AB6M-M2PLW
- Key Selector Switch: AS6M-2KT2PA Pilot Light: UP9P-2498G

Note 2: Silicon rubber: Can be used in general factories. Remains flexible in cold temperatures. Suitable in applications with a wide operating temperature range.

Note 3: NBR/PVC polyblend: Oil-proof. Suitable for environments subjected to machine oil and painting robots where silicon rubber cannot be used.

Additional Switch Layout

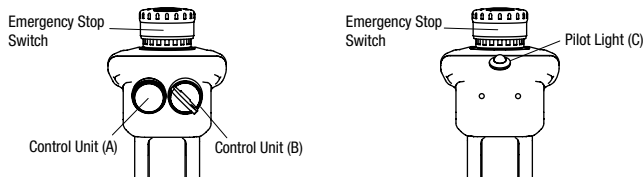

HE2G Grip Style Three-position Enabling Switches

Contact Ratings

Rated Insulation Voltage (Ui)				250V (momentary pushbutton and key selector: 125V) / 30V (with pilot light)			
Rated Thermal Current (Ith)				3A (emergency stop switch: 5A)*			
Rated Voltage (Ue)				30V	125V	250V	
Rated Current	Grip Style Enabling Switch	3-position switch (Terminal No. NO1-C1/A1-B1, NO2-C2/A3-B3)	AC	Resistive Load (AC-12)	—	1A	0.5A
				Inductive Load (AC-15)	—	0.7A	0.5A
			DC	Resistive Load (DC-12)	1A	0.2A	—
			Inductive Load (DC-13)	0.7A	0.1A	—	
		Monitor Switch (NC contact) (Terminal No. 31-32/A2-B2)	AC	Resistive Load (AC-12)	—	2.5A	1.5A
				Inductive Load (AC-15)	—	1.5A	0.75A
	DC		Resistive Load (DC-12)	2.5A	1.1A	0.55A	
		Inductive Load (DC-13)	2.3A	0.55A	0.27A		
	Switch & Pilot Light	Emergency Stop Switch XA1E-BV3U02 (Terminal No.1-2/A1-B1, 1-2/A2-B2)	AC	Resistive Load (AC-12)	—	5A	3A
				Inductive Load (AC-15)	—	3A	1.5A
			DC	Resistive Load (DC-12)	2A	0.4A	0.2A
			Inductive Load (DC-13)	1A	0.22A	0.1A	
Momentary Pushbutton Key Selector Switch AB6M-M2PLW, AS6M-2KT2PA (Terminal No.C1/B1, NO1/B2, NC1/B3, C2/A1, NO2/A2, NC2/A3)		AC	Resistive Load (AC-12)	—	0.5A	—	
			Inductive Load (AC-15)	—	0.3A	—	
	DC	Resistive Load (DC-12)	1A	0.2A	—		
	Inductive Load (DC-13)	0.7A	0.1A	—			
UP9 Pilot Light UP9P-2498G (Terminal No. +, -)				Rated operating voltage: 24V DC ±10% Rated current: 15mA			

Note: Minimum applicable load (reference value): 3V AC/DC, 5 mA (Applicable range is subject to the operating conditions and load.)

*Operating temperature for internal connectors:
 -25°C min., 40°C max. 2.5A (12 to 19 poles), 2A (20 to 22 poles)
 40°C min., 50°C max. 2.5A (8 to 12 poles), 2A (13 to 22 poles)
 50°C min., 60°C max. 2.5A (6, 7 poles), 2A (8 to 13 poles), 1.5A (14 to 22 poles)

Specifications

Applicable Standards	IEC60947-5-1 EN60947-5-1 (TUV approval) JIS C8201-5-1 IEC60847-5-8, EN60947-5-8(TUV approval) GS-ET-22(TUV approval) UL508 (UL recognized) CSA C22.2 No.14 (c-UL recognized) GB14048.5 (CCC approval) KS C IEC60947-5-1/S1-G-1 (KOSHA approval)
Applicable Standards for Use	ISO12100/EN ISO12100 IEC60204-1/EN60204-1 ISO11161/EN ISO11161 ISO10218-1/EN ISO10218-1 ANSI/RIA/ISO10218-1 ANSI/RIA R15.06, ANSI B11.19 ISO13849-1/EN ISO13849-1
Operating Temperature	Silicon rubber boot: -25 to 60°C (no freezing) NBR/PVC Polyblend rubber boot: -10 to 60°C (no freezing)
Relative Humidity	45 to 85% (no condensation)
Storage Temperature	-40 to +80°C (no freezing)
Pollution Degree	3
Contact Resistance	50 mΩ maximum (initial value)
Insulation Resistance	Between live and dead metal parts: 100 MΩ minimum (500V DC megger) Between terminals of different pole: 100 MΩ minimum (500V DC megger)
Impulse Withstand Voltage	(Solder terminal) Grip style enabling switch/emergency stop switch: 2.5 kV Momentary pushbutton/key selector switch: 1.5 kV Pilot light: 500V AC, 1 minute (between live and dead parts) (Internal connector) Grip style enabling switch/emergency stop switch/ momentary pushbutton/key selector switch: 1.5 kV
Electric Shock Protection Class	Class II (IEC 61140) (With pilot light: class III)
Operating Frequency	1,200 operations per hour
Mechanical Durability	Position 1 → 2 → 1: 1,000,000 operations minimum Position 1 → 2 → 3 → 1: 100,000 operations minimum
Electrical Durability	100,000 operations minimum (rated load) 1,000,000 operations minimum (24V AC/DC, 100 mA)
Shock Resistance	Operating extremes: 150 m/s ² Damage limits: 1,000 m/s ²
Vibration Resistance	Operating extremes: 5 to 55 Hz, amplitude 0.5 mm minimum Damage limits: 16.7 Hz, amplitude 1.5 mm minimum
Applicable Wire	Solder terminal: 0.5 mm ² maximum Internal connector: 0.05 to 0.86 mm ² (AWG18 to 30)
Applicable Wire Size	Solder terminal: 0.5 mm ² Internal connector: 0.05 to 0.86 mm ² (AWG18 to 30) (AWG22 between switch and connector)
Applicable Cable	Outside diameter: ø4.5 to 10 mm
Conduit Port Size	M16 (cable gland is supplied)
Terminal Tensile Strength	20N minimum
Degree of Protection	Without switch/pilot light IP67/66 With switch/pilot light IP65
Conditional Short-circuit Current	50A (250V) (Use 250V/10A fast-blow fuse for short circuit protection.)
Direct Opening Force	60N minimum (monitor switch)
Operator Strength	500N minimum (when pressing the entire button surface)
Free Fall	1.0m 1 fall (IEC 60068-2-32 compliant)
Weight (approx.)	HE2G-21SH: 140g HE2G-21SH-P-0/-21SC: 145g HE2G-21SHE/-21SC-P-0: 150g HE2G-21SH-L-L/-21SHE-P-0/-21SCE: 155g HE2G-21SH-L-K/-21SCE-P-0: 160g HE2G-21SHE-L-L/-21SC-L-L: 165g HE2G-21SHE-L-K/-21SC-L-K: 170g HE2G-21SCE-L-L: 175g HE2G-21SCE-L-K: 180g

Operation Characteristics

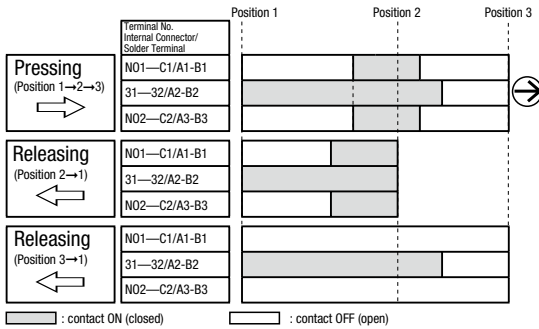

- Terminals N01-C1/A1-B1, N02-C2/A3-B3 are outputs of the 3-position enabling switch.
- The above operation characteristics show when the center of the grip style enabling switch button is pressed. Because two contacts are designed to operate independently, pressing the edge of the button turns on one contact earlier than the other contact, causing a delay in operation. To avoid this, always press the center of the button.

Dimensions

HE2G-21SH/HE2G-21SC

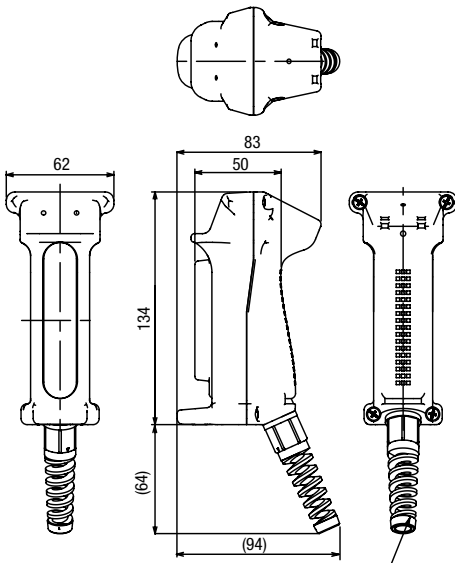

Cable Gland (supplied with grip style enabling switch)
Part No.: SKINTOP BS-M16 × 1.5 (LAPP)

All dimensions in mm.

Internal Connector

Cable side connector:

Tyco Electronics D-1200D Series

- Receptacle: 1-1827864-□
- Receptacle contact
 - 1827586-2: AWG28 to 30 (Hand tool: 1762952-1)
 - 1827587-2: AWG22 to 28 (Hand tool: 1762846-1)
 - 1827588-2: AWG22 to 28 (Hand tool: 1762950-1)
 - 1827589-2: AWG18 to 22 (Hand tool: 1762625-1)

Specify 2 or 3 in place of □.

- 2: 4-pin connector
- 3: 6-pin connector

The customer needs to purchase the connector separately.

Contact Arrangement (Internal Connector)

Internal Connector Pin No.

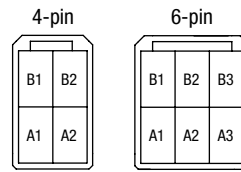

- Emergency stop switch
- 3-position switch
- Momentary pushbutton
- Key selector switch

3-position switch / switch side connector:

- Tyco Electronics D-1200D Series
- Tab housing: 1-1903130-2 (4-pin connector)
- 1-1903130-3 (6-pin connector)
- Tab contact: 19303116-2

Terminal Arrangement (TOP VIEW)

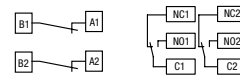

- Emergency stop switch
- Momentary pushbutton
- Key selector switch

6-Pin Connector Allotment Table

Internal Connector Pin No.	Momentary pushbutton Key selector switch
A1	C2
A2	N02
A3	NC2
B1	C1
B2	N01
B3	NC1

- For signal of the 3-position switch, see "Operation Characteristics".
- For solder terminal type terminal arrangement of each switch/pilot light, see each catalog.

APEM

Switches & Pilot Lights

Control Boxes

Emergency Stop Switches

Enabling Switches

Safety Products

Explosion Proof

Terminal Blocks

Relays & Sockets

Circuit Protectors

Power Supplies

LED Illumination

Controllers

Operator Interfaces

Sensors

AUTO-ID

HE1B

HE2B

HE3B

HE5B

HE6B

HE2G

HE1G-L

Actuator w/ Plastic Holder

HE2G Grip Style Three-position Enabling Switches

 Safety Precautions

- The enabling switches have been designed for industrial purposes. Use for residential, commercial, or lighting purposes may cause unwanted electromagnetic disturbances in which case the user may be required to take adequate mitigation measures. (IEC60947-1, Clause 5.3)
- Do not assemble or modify the enabling switches and do not disable the enabling function. Otherwise, failure of accidents may occur.
- When using the enabling switch in a safety related part of a control system, use the enabling switch properly in accordance with the safety standards and regulations of the actual machine, system, and application, of the country or region where the enabling switch is used. Also, perform a risk assessment before using the enabling switch.
- Do not hold the enabling switch to position 2 using tapes or strings. Otherwise the loss of enabling switch function may cause serious accidents.
- Do not use with the grip switch installed on a machine.
- Use wires of the proper size to meet voltage and current requirements.
- Do not apply excessive force to the enabling switch.
- Make sure that dust, water and oil do not enter the grip switch during wiring.
- Be sure to choose cables according to the operating environment.
- If multiple safety components are wired in series, the Performance Level to EN ISO 13849-1 will be reduced due to the restricted error detection under certain circumstance.
- The entire concept of the control system, in which the safety component is integrated, must be validated to EN ISO 13849-2.

Instructions

Operating Instructions

- This grip style three-position enabling switch is a device used for enabling a machine such as robots when teaching the machine in a hazardous area manually. Configure the enabling system so that the machine can operate when the switch is in position 2 and an separate start switch is required to initiate the system.
- To achieve a high level of safety, connect the two contacts of the 3-position switch to a disparity detection circuit (terminal No. N01-C1 and N02-C2) to a discrepancy detection circuit such as a safety relay module. (ISO13849-1/ EN954-1)
- The base and the plastic part of rubber boot frame are made of glass-reinforced ABS/PBT. The rubber boot is made of silicone rubber or NBR/PVC polyblend. The screw is made of iron. When cleaning the grip style three-position enabling switch, use a detergent compatible with the materials.
- When adding momentary pushbutton switch and key selector switch, do not connect NO and NC contacts of a microswitch to different voltages or different power sources to prevent a dead short-circuit.
- When operating a additionally installed key selector switch, be sure to fully insert the key. Otherwise, failure may occur.
- The rubber boot may deteriorate depending on the operating environment and conditions. When the rubber boot is deformed or cracked, replace with new ones.

Wiring Instructions

- Solder the terminal at a temperature of 310 to 350°C within 3 seconds using a soldering iron. Sn-Ag-Cu type is recommended when using lead-free solder. Do not use flow or dip soldering.
- When soldering, take care not to touch the enabling switch with the soldering iron. Also ensure that no tensile force is applied to the terminal. Do not bend the terminal or apply excessive force to the terminal.
- Use non-corrosive liquid rosin as soldering flux.
- Because the terminal spacing is narrow, use protective tubes or heat shrinkable tubes to avoid burning of wire coating or short circuit.
- When using a stranded wire, make sure that adjoining terminals are not short-circuited
- with protruding core wires.
- Use copper Wire 60/75 degree C only. (UL508)
- The wiring has to be installed according to GS-ET-22, 4.2.6.

APEM

Switches & Pilot Lights

Control Boxes

Emergency Stop Switches

Enabling Switches

Safety Products

Explosion Proof

Terminal Blocks

Relays & Sockets

Circuit Protectors

Power Supplies

LED Illumination

Controllers

Operator Interfaces

Sensors

AUTO-ID

HE1B

HE2B

HE3B

HE5B

HE6B

HE2G

HE1G-L

Actuator w/ Plastic Holder

Instructions

Solder Terminal

Wire Length inside the Switch

	Grip Style Enabling Switch								Momentary Pushbutton/ Key Selector Switch			Emergency Stop Switch		Pilot Light	
	N01	C1	11	12	31	32	N02	C2	C	NO	NC	1	2	+	-
Wire stripping length L1 (mm)	40	45	50	60	50	60	85	80	120			110		115	
Wire stripping length L2 (mm)	L2=5mm														

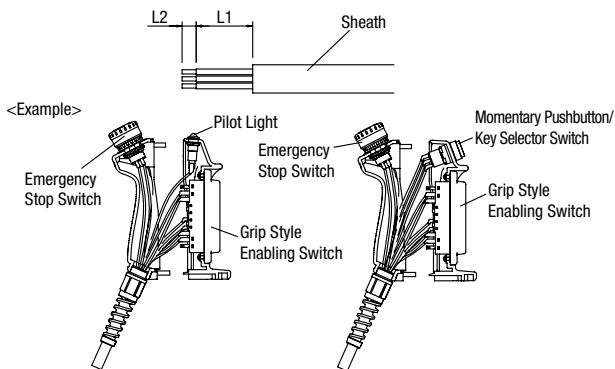

Connector Terminal

Wire Length inside the Switch

	Grip Style Enabling Switch	Momentary Pushbutton/Key Selector Switch	Emergency Stop Switch
Wire stripping length L1 (mm)	20	60	75

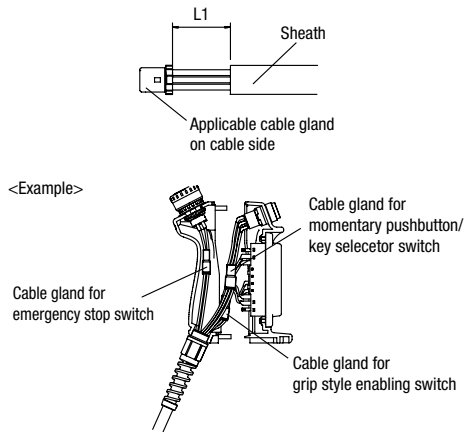

Applicable wire size for the cable gland on cable side

- 0.05 to 0.86mm² (AWG18 to 30): Check the compliance with receptacle and contact.

Tool: 1762846-1 (manual tool)

Note: When using stranded wires, make sure that loose wires do not cause short circuit. Also, do not solder the terminals to prevent loose wires. Use copper wire of 60°C or 75°C temperature rating in order to comply with UL508. Observe the requirements of GS-ET-22: 2003, 4.2.6 for wiring.

Applicable Wire Size

0.5mm² maximum (Observe the requirements of IEC 60204-1 for wiring.)

Recommended Tightening Torque

Parts for tightening		Torque
A	Base and rubber kit (M4 screw × 4)	1.1 to 1.3 N·m
B	Cable gland and grip style enabling switch	2.7 to 3.3 N·m
C	Cable gland	2.7 to 3.3 N·m
D	HE2B Enabling Switch (M3 screws × 2) *	0.5 to 0.8 N·m

Note: The recommended tightening torques of B and C are for the supplied cable gland. When using another cable gland, refer to the tightening torque of the cable gland used.

* For replacing HE2B enabling switch or rubber boot only

mended connector is used. When using another connector, refer to the specifications of the connector used.

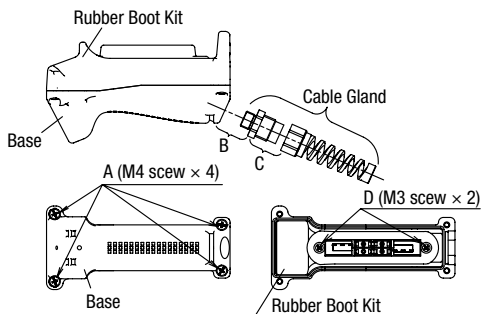

HE1G-L Grip Style Three-position Enabling Switches

The distinctive tactile feedback makes it easy to know the current position of the switch.
Light operating force ideal for long-hour operation

- Ergonomically-designed OFF-ON-OFF operation.
- The switch does not turn ON when being released from position 3 (OFF when pressed) to position 1 (OFF when released) (IEC 60204-1, 9.2.5.8).
- Two contacts are provided so that even if one contact fails due to welding or short-circuit, the other contact can disable machine operation.
- Monitor switch is direct opening action.
- The distinctive tactile feedback when shifting to position 2 (enabling position) makes it easier to know where the enabling switch is currently positioned—position 1 (OFF), 2 (ON), or 3 (OFF).
- Lighter operating force on position 2 assures more comfortable, stress-free operation when operating long hours.
- Emergency stop switch and momentary pushbutton versions are available.
- Screw terminal and internal connector models can be selected.
- IP66 degree of protection (HE1G-L21SM)

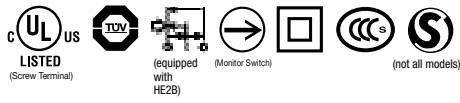

HE1G-L

Package Quantity: 1

	Contact Configuration			Rubber Boot	Wiring Style	Part No.
	3-position Switch	Monitor Switch	Additional Pushbutton Switch			
HE1B HE2B HE3B HE5B HE6B	2 contacts	With (1NC)	Without	Silicon Rubber / yellow (Note 1)	Terminal Block	HE1G-L21SM
				Internal Connector	HE1G-L21SMC	
			NBR/PVC Polyblend / gray (Note 2)	Terminal Block	HE1G-L21SM-1N	
		Momentary Pushbutton Switch (1NO: AB6M-M1PB)	Silicon Rubber / yellow	Terminal Block	HE1G-L21SMB	
			Internal Connector	HE1G-L21SMCB		
			NBR/PVC Polyblend / gray	Terminal Block	HE1G-L21SMB-1N	
	Without	Emergency Stop Switch (2NC: HA1E-V2S2R)	Silicon Rubber / yellow	Terminal Block	HE1G-L20ME	
			Internal Connector	HE1G-L20MCE		
			NBR/PVC Polyblend / gray	Terminal Block	HE1G-L20ME-1N	
		Momentary Pushbutton Switch (2NO: AB6M-M2PB)	Internal Connector	HE1G-L20MCE-1N		
			Silicon Rubber / yellow	Terminal Block	HE1G-L20MB	
			Internal Connector	HE1G-L20MCB		
			NBR/PVC Polyblend / gray	Terminal Block	HE1G-L20MB-1N	
			Internal Connector	HE1G-L20MCB-1N		

Note 1: Silicon rubber: Can be used in general factories. Remains flexible at cold temperatures. Suitable to applications in a wide operating temperature range.
Note 2: NBR/PVC polyblend: Oil-proof. Suitable for environments subjected to machine oil and painting robot where silicon rubber cannot be used.

Contact Ratings

Rated Insulation Voltage (Ui)		250V (momentary pushbutton: 125V)			
Rated Thermal Current (Ith)		2.5A (Note)			
Rated Voltage (Ue)		30V	125V	250V	
Rated Current (Ie)	3-position Switch (Terminal No.1-2/A1-B1,3-4/A2-B2)	AC	Resistive Load (AC-12)	—	0.5A
			Inductive Load (AC-15)	—	0.5A
		DC	Resistive Load (DC-12)	1A	0.2A
	Inductive Load (DC-13)		0.7A	0.1A	—
	Grip Style Enabling Switch (HE1G-L21SM/ HE1G-L21SMB, Terminal No.5-6/A3-B3)	AC	Resistive Load (AC-12)	—	1.5A
			Inductive Load (AC-15)	—	0.75A
DC			Resistive Load (DC-12)	2.5A	1.1A
		Inductive Load (DC-13)	2.3A	0.55A	0.27A
		Emergency Stop Switch (HE1G-L20M, Terminal No. 5-6/A3-B3, 7-8/A4-B4)	AC	Resistive Load (AC-12)	—
Inductive Load (AC-15)				—	0.5A
DC	Resistive Load (DC-12)		—	—	—
	Inductive Load (DC-13)	—	—	0.1A	
Pushbutton (HE1G-L20M, Terminal No.5-6/A3-B3, 7-8/A4-B4) (HE1G-L21SM, Terminal No.7-8/A4-B4)	AC	Resistive Load (AC-12)	—	—	
		Inductive Load (AC-15)	—	0.5A	
	DC	Resistive Load (DC-12)	—	—	—
		Inductive Load (DC-13)	—	—	—
		Resistive Load (AC-12)	—	0.5A	—
		Inductive Load (AC-15)	—	0.3A	—
DC	Resistive Load (DC-12)	1A	0.2A	—	
	Inductive Load (DC-13)	0.7A	0.1A	—	

- Minimum applicable load (reference value): 3V AC/DC, 5 mA (Applicable range is subject to the operating conditions and load.)
- Note: Operating temp. 40 to up to +50°C (not included): 2A (4 circuits)
50 to +60°C: 1.5A (3 or 4 circuits)

Specifications

Applicable Standards	IEC60947-5-1, EN60947-5-1 (TÜV approval) JIS C8201-5-1, IEC60947-5-8, EN60947-5-8 (TÜV approval) GS-ET-22 (TÜV approval) UL508 (UL listed) (screw terminal only) CSA C22.2 No. 14 (c-UL listed) (screw terminal only) KS C IEC60947-5-1/S1-G-1 (KOSHA approval)
Applicable Standards for Use	ISO12100-1, -2/EN12100-1, -2 IEC60204-1/EN60204-1, ISO11161/prEN11161 ISO10218/EN775, ANSI/RIA R15.06 ANSI B11.19
Operating Temperature	Silicon rubber boot: -25 to 60°C (no freezing) NBR/PVC Polyblend rubber boot: -10 to 60°C (no freezing)
Relative Humidity	45 to 85% (no condensation)
Storage Temperature	-40 to +80°C (no freezing)
Pollution Degree	3
Contact Resistance	100 mΩ maximum (initial value)
Insulation Resistance	Between live and dead metal parts: 100 MΩ minimum (500V DC megger) Between terminals of different pole: 100 MΩ minimum (500V DC megger)
Impulse Withstand Voltage	Screw terminal: 2.5 kV (momentary pushbuttons: 1.5 kV) Internal connector: 1.5 kV
Electric Shock Protection Class	Class II (IEC 61140)
Operating Frequency	1,200 operations per hour
Mechanical Durability	Position 1 → 2 → 1: 1,000,000 operations minimum Position 1 → 2 → 3 → 1: 100,000 operations minimum
Electrical Durability	100,000 operations minimum (rated load) 1,000,000 operations minimum (24V AC/DC, 100 mA)
Shock Resistance	Operating extremes: 150 m/s ² Damage limits: 1,000 m/s ²
Vibration Resistance	Operating extremes: 5 to 55 Hz, amplitude 0.5 mm minimum Damage limits: 16.7 Hz, amplitude 1.5 mm minimum
Applicable Wire	Screw terminal: 0.14 to 1.5 mm ² (AWG16 to 25) Internal connector: 0.05 to 0.86 mm ² (AWG18 to 30)
Applicable Cable	Outside diameter ø7 to 13 mm
Conduit Port Size	M20 (cable gland is supplied with the grip style enabling switch)
Terminal Tensile Strength	20N minimum
Terminal Screw Tightening Torque	0.5 to 0.6 N·m
Degree of Protection	HE1G-L21SM: IP66 (IEC 60529) HE1G-L20ME: IP65 (IEC 60529) HE1G-L20MB: IP65 (IEC 60529) HE1G-L21SMB: IP65 (IEC 60529)
Conditional Short-circuit Current	50A (250V) (Use 250V/10A fast-blow fuse for short circuit protection.)
Direct Opening Force	70N minimum (monitor switch)
Operator Strength	500N minimum (when pressing the entire button surface)
Weight (approx.)	HE1G-L21SMC: 190g HE1G-L21SM/L21SMCB/L20MCB: 200g HE1G-L21SMB/L20MB: 210g HE1G-L20MCE: 230g HE1G-L20ME: 240g

Operating Characteristics

HE1G-L21SM, HE1G-L21SMC,
HE1G-L21SM-1N, HE1G-L21SMC-1N

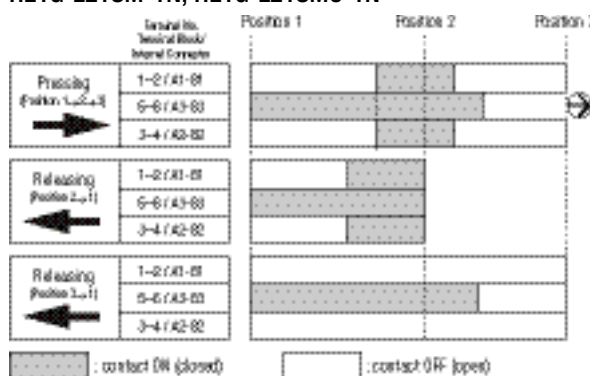

- Terminals 1-2/A1-B1 and 3-4/A2-B2 are outputs of the 3-position enabling switch.
- Terminals 5-6/A3-B3 are outputs of the monitor switch.
- The above operation characteristics show when the center of the grip style enabling switch button is pressed. Because two contacts are designed to operate independently, pressing the edge of the button turns on one contact earlier than the other contact, causing a delay in operation. To avoid this, always press the center of the button.

Dimensions

HE1G-L21SM, HE1G-L21SMC,
HE1G-L21SM-1N, HE1G-L21SMC-1N

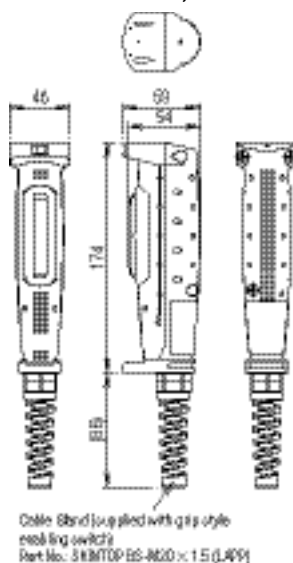

Internal Connector Terminal No.

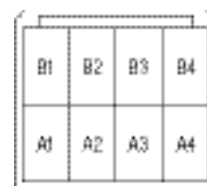

Connector

Tyco Electronics D-1200D series

- Receptacle housing: 1-1827864-4
- Receptacle contact
 - 1827586-2: AWG28 to 30 (Hand tool: 1762952-1)
 - 1827587-2: AWG22 to 28 (Hand tool: 1762846-1)
 - 1827588-2: AWG22 to 28 (Hand tool: 1762950-1)
 - 1827589-2: AWG18 to 22 (Hand tool: 1762625-1)

Accessory

Mounting Bracket HE9Z-GH1 (for hanging the switch)

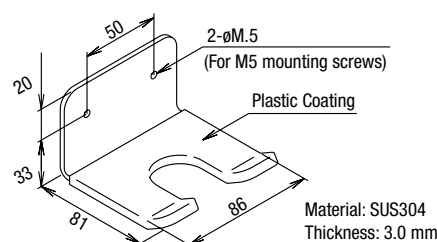

Note: Available for HE1G/HE1G-L/HE9Z-GSH51 only.

- APEM
- Switches & Pilot Lights
- Control Boxes
- Emergency Stop Switches
- Enabling Switches
- Safety Products
- Explosion Proof
- Terminal Blocks
- Relays & Sockets
- Circuit Protectors
- Power Supplies
- LED Illumination
- Controllers
- Operator Interfaces
- Sensors
- AUTO-ID

- HE1B
- HE2B
- HE3B
- HE5B
- HE6B
- HE2G
- HE1G-L
- Actuator w/ Plastic Holder

HE1G-L Grip Style Three-position Enabling Switches

Safety Precautions

- The enabling switches have been designed for industrial purposes. Use for residential, commercial, or lighting purposes may cause unwanted electromagnetic disturbances in which case the user may be required to take adequate mitigation measures. (IEC60947-1, Clause 5.3)
- Do not assemble or modify the enabling switches and do not disable the enabling function. Otherwise, failure of accidents may occur.
- When using the enabling switch in a safety related part of a control system, use the enabling switch properly in accordance with the safety standards and regulations of the actual machine, system, and application, of the country or region where the enabling switch is used. Also, perform a risk assessment before using the enabling switch.
- Do not hold the enabling switch to position 2 using tapes or strings. Otherwise the loss of enabling switch function may cause serious accidents.
- Do not use with the grip switch installed on a machine.
- Use wires of the proper size to meet voltage and current requirements.
- Do not apply excessive force to the enabling switch.
- Make sure that dust, water and oil do not enter the grip switch during wiring.
- Be sure to choose cables according to the operating environment.
- If multiple safety components are wired in series, the Performance Level to EN ISO 13849-1 will be reduced due to the restricted error detection under certain circumstance.
- The entire concept of the control system, in which the safety component is integrated, must be validated to EN ISO 13849-2.

Instructions

Operating Instructions

- This grip style three-position enabling switch is a device used for enabling a machine such as robots when teaching the machine in a hazardous area manually. Configure the enabling system so that the machine can operate when the switch is in position 2 and an separate start switch is required to initiate the system.
- To achieve a high level of safety, connect the two contacts of the 3-position switch to a disparity detection circuit (terminal No. N01-C1 and N02-C2) to a discrepancy detection circuit such as a safety relay module. (ISO13849-1/ EN954-1)
- The base and the plastic part of rubber boot frame are made of glass-reinforced ABS/PBT. The rubber boot is made of silicone rubber or NBR/PVC polyblend. The screw is made of iron. When cleaning the grip style three-position enabling switch, use a detergent compatible with the materials.
- The rubber boot may deteriorate depending on the operating environment and conditions. When the rubber boot is deformed or cracked, replace with new ones.

Wiring Instructions

Screw Terminal Type

Wire Length inside the Grip Style Enabling Switch

	Terminal No. 1-4	Terminal No. 5-8
Wire length L1, L2 (mm)	L1 = 40 mm	L2 = 27 mm
Wire stripping length L3 (mm)	L3 = 6 mm	

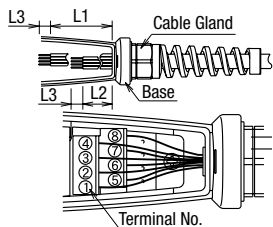

Applicable Wire Size

<Direct wiring>

0.14 to 1.5 mm² (one wire per terminal)

Note: When using stranded wire, make sure that adjoining terminals are not short-circuited by frayed wires. Also, do not solder the wires to avoid frayed wires.

<Ferrules>

Recommended ferrules (Phoenix Contact)

Part No.	Applicable Wire
Al 0,5-8 WH	0.34 to 0.5 mm ²
Al 0,75-8 GY	0.5 to 0.75 mm ²
Al 1,0-8 RD	0.75 to 1.0 mm ²
Al 1,5-8 BK	1.0 to 1.5 mm ²

Crimping tool: CRIMPFOX UD6

Recommended Tightening Torque

Parts for Tightening		Torque
A	Rubber boot and the base (M4 screw × 3)	1.2 ± 0.1 N·m
B	Connector and grip style enabling switch	4.0 ± 0.3 N·m
C	Connector and connector	4.0 ± 0.3 N·m
D	Terminal screw (M3 screw × 8)	0.5 to 0.6 N·m
E	Do not remove screws	—

The torque of screws B and C in the table above are values when the recommended connector is used. When using another connector, refer to the specifications of the connector used.

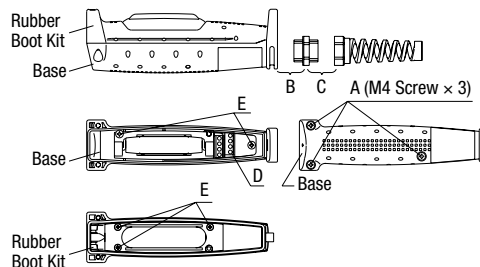

- APEM
- Switches & Pilot Lights
- Control Boxes
- Emergency Stop Switches
- Enabling Switches
- Safety Products
- Explosion Proof
- Terminal Blocks
- Relays & Sockets
- Circuit Protectors
- Power Supplies
- LED Illumination
- Controllers
- Operator Interfaces
- Sensors
- AUTO-ID
- HE1B
- HE2B
- HE3B
- HE5B
- HE6B
- HE2G
- HE1G-L
- Actuator w/ Plastic Holder

Instructions

Connector Terminal

Wire Length inside the Switch

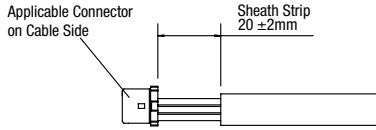

Applicable wire size for the cable gland on cable side

- 0.05 to 0.86mm² (AWG18 to 30): Check the compliance with receptacle and contact.

Tool: 1762846-1 (manual tool)

Observe the requirements of GS-ET-22: 2003, 4.2.6 for wiring.

Note: When using stranded wires, make sure that loose wires do not cause short circuit. Also, do not solder the terminals to prevent loose wires. Use copper wire of 60°C or 75°C temperature rating in order to comply with UL508. Observe the requirements of GS-ET-22: 2003, 4.2.6 for wiring.

Recommended Tightening Torque

Parts for Tightening		Torque
A	Base and rubber kit (M4 screw × 3)	1.1 to 1.3 N·m
B	Cable gland and grip style enabling switch	3.7 to 4.3 N·m
C	Cable gland	3.7 to 4.3 N·m
D	Do not touch	—

Note: The recommended tightening torques of B and C are for the supplied cable gland. When using another cable gland, refer to the tightening torque of the cable gland used.

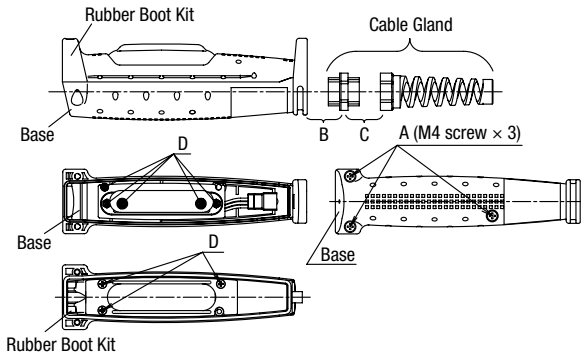

Actuator with Plastic Holder

HS5 series interlock switches detect the installation/removal of grip style enabling switches.

- The actuator with plastic holder for the HS5 series interlock switches can be installed onto the HE1G/HE1G-L/HE2G grip style enabling switches easily using the two mounting screws supplied with the actuator.
- Inserting the actuator on the grip style enabling switch into the entry slot of HS5D/HS5B/HS5E/HS5E-K interlock switch, the grip style enabling switch can be retained firmly in position.
- Using with HS5E/HS5E-K interlock switches prevent unauthorized removal of grip style enabling switches.
- Easy switching by removing/installing the grip style enabling switches can be achieved by designing the circuit to initiate automatic or manual operation when the interlock switch is installed or removed, respectively.

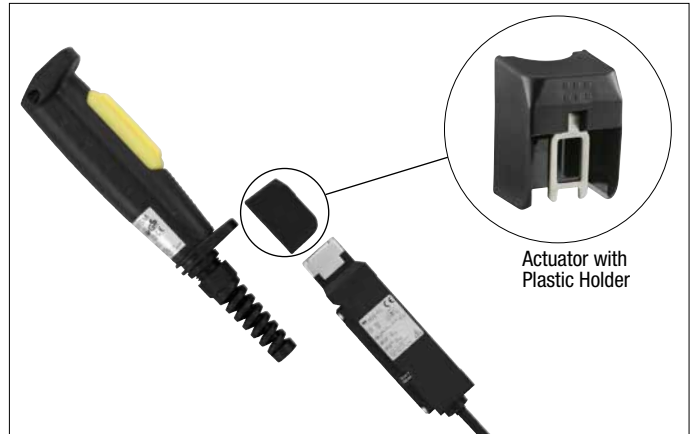

- APEM
- Switches & Pilot Lights
- Control Boxes
- Emergency Stop Switches
- Enabling Switches
- Safety Products
- Explosion Proof
- Terminal Blocks
- Relays & Sockets
- Circuit Protectors
- Power Supplies
- LED Illumination
- Controllers
- Operator Interfaces
- Sensors
- AUTO-ID

Description	Part No.
Actuator with plastic holder for HE1G/HE1G-L/HE2G	HE9Z-GP15

Note: The HE1G/HE1G-L/HE2G grip style enabling switches and HS5 series interlock switches are ordered separately.

Specifications

Applicable Model	HE1G/HE1G-L/HE2G Grip Style Enabling Switch HS5D/HS5B/HS5E/HS5E-K Interlock Switch
Mechanical Durability	10,000 operations
Weight (approx.)	30g

Note: Refer to the specifications of HE1G/HE1G-L/HE2G grip style enabling switches and HS5D/HS5L/HS5E/HS5E-K interlock switches.

Dimensions

When used with an HE1G/HE1G-L and HS5D/HS5B

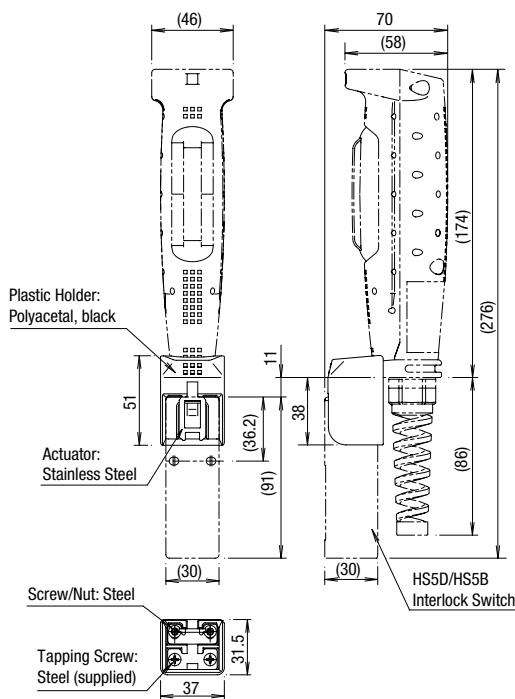

When used with an HE1G/HE1G-L and HS5E/HS5E-K

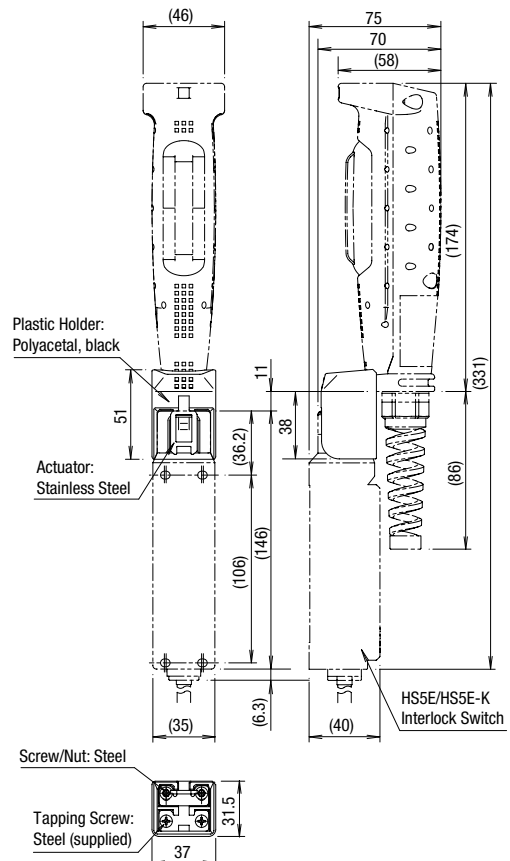

All dimensions in mm.

APEM
Switches & Pilot Lights
Control Boxes
Emergency Stop Switches
Enabling Switches
Safety Products
Explosion Proof
Terminal Blocks
Relays & Sockets
Circuit Protectors
Power Supplies
LED Illumination
Controllers
Operator Interfaces
Sensors
AUTO-ID
HE1B
HE2B
HE3B
HE5B
HE6B
HE2G
HE1G-L
Actuator w/ Plastic Holder

Instructions

Mounting

① The HE9Z-GP15 and the HE1G/HE1G-L are installed as shown in the following figure.

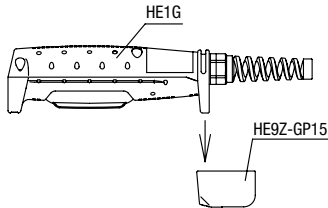

② Secure the actuator using the attached two screws in the direction of the arrow as shown in the following figure.

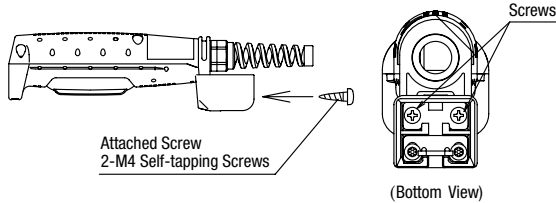

- Using the attached screws (M4 self-tapping screw × 2), secure the HE9Z-GP15 to the grip style enabling switch. Recommended tightening torque: 1.0 ±0.1 N·m. Do not use excessive force to tighten the HE9Z-GP15 onto the switch, otherwise the mounting holes will become deformed and the HE9Z-GP15 cannot be secured. Prevent the screws from loosening by applying epoxy. (Recommended: LOCTITE 425, ThreeBond 1401)

Precautions for Installation

- When using the HE9Z-GP15 for safety-related equipment in a control system, refer to safety standards and regulations in each country and region to make sure of correct operation. Also, perform a risk assessment to ensure safety before starting operation of the machine.
- Read the instruction sheets for both the grip style enabling switch and interlock switch to be used.
- Insert the HE9Z-GP15 in the direction shown in the following figure only. Do not insert from any other direction. Also, do not use the slot plug attached to the interlock switch.

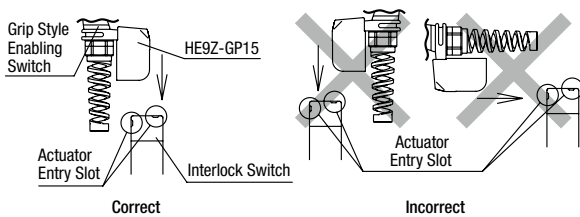

- See below for vertical installation. Do not install in any other direction. Also, make sure that the mounting surface is provided for the entire area of the grip style enabling switch, so that the switch does not tilt as shown below. Otherwise the HE9Z-GP15 actuator will be deformed.

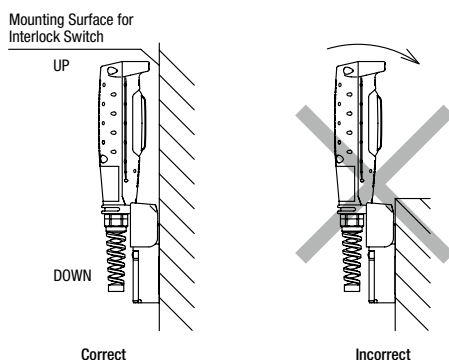

- Do not install the grip style enabling switch and the interlock switch in an area subjected to vibration. Excessive vibration may cause malfunction of the switch contacts of the grip style enabling switch. Also, exposure to vibration for a long period of time can cause scratching and deformation of plastic parts.
- When installing or removing the grip style enabling switch, do not use excessive force in any direction other than shown in the following figure. Otherwise the HE9Z-GP15 actuator can become deformed or damaged.

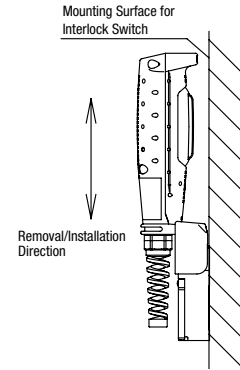

- Make sure that the HE9Z-GP15 actuator is inserted completely into the interlock switch. Avoid any foreign objects between the actuator and interlock switch as they may interfere with the plastic spring, resulting in possible damage to the actuator.

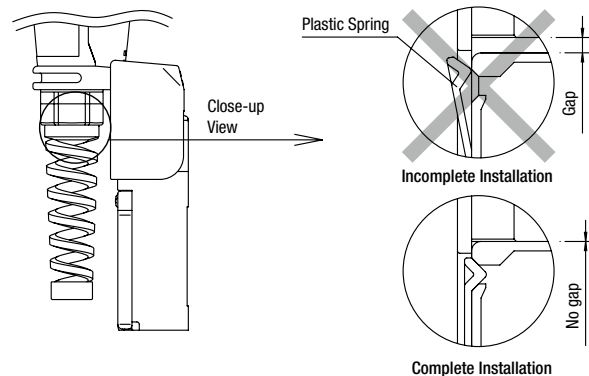

- When manually unlocking the HS5E interlock switch attached to the grip style enabling switch, bend the spiral part of the connector slightly to be able to access the manual unlock key.

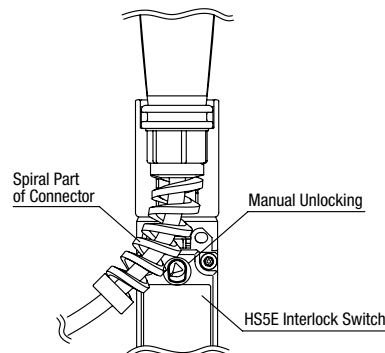

- Do not apply excessive shocks to the HE9Z-GP15 when attached to the interlock switch, otherwise the actuator may be removed from the interlock switch. Also excessive shocks may result in damage or failure of the interlock switch.
- When the plastic part of the HE9Z-GP15 or the actuator is damaged or deformed, stop using immediately.
- The HE9Z-GP15 is used for HE1G/HE1G-L/HE2G grip style enabling switch and HS5D/HS5B/HS5E/HS5E-K interlock switches only. Do not use the HE9Z-GP15 for other products.
- Do not modify or disassemble the HE9Z-GP15.

Enabling Switches

- APEM
- Switches & Pilot Lights
- Control Boxes
- Emergency Stop Switches
- Enabling Switches
- Safety Products
- Explosion Proof
- Terminal Blocks
- Relays & Sockets
- Circuit Protectors
- Power Supplies
- LED Illumination
- Controllers
- Operator Interfaces
- Sensors
- AUTO-ID

- HE1B
- HE2B
- HE3B
- HE5B
- HE6B
- HE2G
- HE1G-L
- Actuator w/
Plastic Holder



Benelux B: (+32) 27 25 05 00 - sales@apem.be
 NL: (+31) (70) 799 91 51 - sales@apem.be
 France (+33) 5 63 93 14 98 - commercial@apem.fr
 Germany Munich: (+49) 89 45 99 11 0 - info@apem.de
 Hamburg: (+49) 40 253054 0 - info@apem.de
 Italy (+39) 0172 74 3170 - apem.italia@apem.it
 Sweden (+46) 8 626 38 00 - info@apem.se
 United Kingdom (+44) 1 844 202400 - sales@apem.co.uk